

Data sheet

# ELIMINATOR® Hermetic bi-flow filter drier

## Types DMB and DCB



Hermetic bi-flow filter driers, types DMB and DCB are for use in liquid lines on heat pumps.

Hermetic bi-flow filter driers have built-in check valves which ensure that refrigerant liquid always flows through the filter driers from the outer side of the filter core towards the center. Thus all dirt particles are retained irrespective of flow direction.

DMB and DCB filter driers ensure fast and effective adsorption of moisture as well as organic and inorganic acids.

When building heat pump systems, the use of bi-flow filters can, depending on the type of system, save up to ten solder connections. This reduces production costs and the number of potential leakage points.

Available with flare and solder (pure copper) connections.

For other connections please contact your Danfoss Sales Representative.

### Features

#### The Core type DMB

- 100% 3Å Molecular Sieve core
- High drying capacity minimizing the risk of acid formation (hydrolysis)
- Recommended for use with HFO, HC, HFC and HCFC refrigerants
- Will not deplete oil additives

#### The Core type DCB

- 80% 3Å Molecular Sieve with 20% activated alumina
- Perfect core blend for systems that operate at high condensing temperatures and require high drying capacity
- Recommended for use with HFO, HC, HFC and HCFC refrigerants

#### The Shell

- PED approved for PS 46 bar
- Available with solder (pure copper) and flare connections
- Optimum flow characteristics and dirt retention
- The check valves are not sensitive to dirt and give minimum restriction, irrespective of flow direction

#### The Filter

- Effective dirt removal to 25 µm
- No dirt released by reversing the flow direction
- Available in sizes 8 – 30 cubic inches

**Approvals**

UL US, file no. SA 6398  
 PED 97/23/EC - a3p3  
 Compliant with ATEX hazard zone 2

**▲ Note:** Only solder versions (cu-plated / pure copper) and connection sizes below 25 mm are approved for flammable refrigerants now.

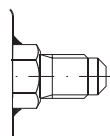
**Technical data**

Flare connection

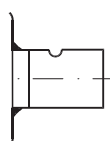

Solder connection (pure copper)

**Surface and volume**

Filter	Solid core surface	Solid core volume	Filter drier volume (shell volume)	Filter drier volume (net volume)
	[cm <sup>2</sup> ]	[cm <sup>3</sup> ]	[l]	[l]
DMB/DCB 08	73	80	0.10	0.088
DMB/DCB 16	100	145	0.30	0.234
DMB/DCB 30	250	365	0.49	0.322

**Acid capacity**

Filter	Acid capacity <sup>1)</sup>
	[g]
DCB 08	0.96
DCB 16	1.29
DCB 30	3.16

<sup>1)</sup> Adsorption capacity of oleic acid at 0.05 TAN (Total Acid Number)

Temperature range:  
 -40 – 70 °C

Dirt retention:  
 Particles > 25 µm

**Technical data and capacities**
**Drying and liquid capacity, type DMB**

Type	Drying capacity [kg] refrigerant <sup>1)</sup>												Liquid capacity [kW] <sup>2)</sup>						Max. Working Pressure PS [bar]
	R134a		R404A		R507		R22		R407C		R410A		R134a	R404A	R507	R22	R407C	R410A	
	[°C]																		
	24	52	24	52	24	52	24	52	24	52	24	52							
DMB 082/082s	9.1	8.6	9.7	9.2	9.9	9.2	9.2	8.5	9.1	8.4	8.3	7.6	3.9	2.8	2.8	4.3	4.3	4.3	46
DMB 083/083s	9.1	8.6	9.7	9.2	9.9	9.2	9.2	8.5	9.1	8.4	8.3	7.6	7.4	5.3	5.3	8.2	8.2	8.2	46
DMB 084/084s	9.1	8.6	9.7	9.2	9.9	9.2	9.2	8.5	9.1	8.4	8.3	7.6	8.3	6.0	6.0	9.2	9.2	9.2	46
DMB 162	17.1	16.2	18.4	17.4	18.7	17.3	17.3	16.0	17.1	15.8	15.6	14.4	7.6	5.3	5.3	8.8	8.8	8.8	46
DMB 163/163s	17.1	16.2	18.4	17.4	18.7	17.3	17.3	16.0	17.1	15.8	15.6	14.4	18.0	13.0	13.0	20.0	20.0	20.0	46
DMB 164/164s	17.1	16.2	18.4	17.4	18.7	17.3	17.3	16.0	17.1	15.8	15.6	14.4	28.0	20.0	20.0	32.0	32.0	32.0	46
DMB 165/165s	17.1	16.2	18.4	17.4	18.7	17.3	17.3	16.0	17.1	15.8	15.6	14.4	37.0	29.0	29.0	40.0	40.0	40.0	46
DMB 303	42.0	39.7	45.2	42.8	46.0	42.5	42.5	39.3	42.1	38.9	38.3	35.3	19.0	15.0	15.0	21.0	21.0	21.0	46
DMB 304/304s	42.0	39.7	45.2	42.8	46.0	42.5	42.5	39.3	42.1	38.9	38.3	35.3	28.0	20.0	20.0	31.0	31.0	31.0	46
DMB 305/305s	42.0	39.7	45.2	42.8	46.0	42.5	42.5	39.3	42.1	38.9	38.3	35.3	38.0	28.0	28.0	42.0	42.0	42.0	46
DMB 307s	42.0	39.7	45.2	42.8	46.0	42.5	42.5	39.3	42.1	38.9	38.3	35.3	43.0	32.0	32.0	47.0	47.0	47.0	46

<sup>1)</sup> Drying capacity is based on following moisture content test standards before and after drying:

- R134a: 1050 – 50 ppm W
- R404A, R507: 1020 – 50 ppm W
- R407C: 1020 – 50 ppm W
- R410A: 1050 – 50 ppm W
- R22: 1050 – 60 ppm W

In accordance with ARI 710-2004

<sup>2)</sup> Given in accordance with ARI 710-2004 for

- t<sub>e</sub> = -15 °C
- t<sub>c</sub> = 30 °C
- Δp = 0.07 bar

For technical data on other refrigerants, please contact your Danfoss Sales Representative

**Technical data and capacities**
**Drying and liquid capacity , type DCB**

Type	Drying capacity [kg] refrigerant <sup>1)</sup>												Liquid capacity [kW] <sup>2)</sup>						Max. Working Pressure PS [bar]
	R134a		R404A		R507		R22		R407C		R410A		R134a	R404A	R507	R22	R407C	R410A	
	[°C]																		
	24	52	24	52	24	52	24	52	24	52	24	52							
DCB 082 / 082s	7.1	6.7	7.6	7.2	7.7	7.1	7.1	6.6	7.1	6.5	6.4	5.9	3.9	2.8	2.8	4.3	4.3	4.3	46
DCB 083 / 083s	7.1	6.7	7.6	7.2	7.7	7.1	7.1	6.6	7.1	6.5	6.4	5.9	7.4	5.3	5.3	8.2	8.2	8.2	46
DCB 084 / 084s	7.1	6.7	7.6	7.2	7.7	7.1	7.1	6.6	7.1	6.5	6.4	5.9	8.3	6.0	6.0	9.2	9.2	9.2	46
DCB 162	13.3	12.6	14.3	13.6	14.6	13.5	14.6	12.5	13.4	11.6	12.2	11.2	7.6	5.3	5.3	8.8	8.8	8.8	46
DCB 163 / 163s	13.3	12.6	14.3	13.6	14.6	13.5	14.6	12.5	13.4	11.6	12.2	11.2	18.0	13.0	13.0	20.0	20.0	20.0	46
DCB 164 / 164s	13.3	12.6	14.3	13.6	14.6	13.5	14.6	12.5	13.4	11.6	12.2	11.2	28.0	20.0	20.0	32.0	32.0	32.0	46
DCB 165 / 165s	13.3	12.6	14.3	13.6	14.6	13.5	14.6	12.5	13.4	11.6	12.2	11.2	37.0	29.0	29.0	40.0	40.0	40.0	46
DCB 303	32.8	31.0	35.8	33.4	35.8	33.1	33.2	30.7	32.8	30.3	29.9	27.5	19.0	15.0	15.0	21.0	21.0	21.0	46
DCB 304 / 304s	32.8	31.0	35.8	33.4	35.8	33.1	33.2	30.7	32.8	30.3	29.9	27.5	28.0	20.0	20.0	31.0	31.0	31.0	46
DCB 305 / 305s	32.8	31.0	35.8	33.4	35.8	33.1	33.2	30.7	32.8	30.3	29.9	27.5	38.0	28.0	28.0	42.0	42.0	42.0	46
DCB 307s	32.8	31.0	35.8	33.4	35.8	33.1	33.2	30.7	32.8	30.3	29.9	27.5	43.0	32.0	32.0	47.0	47.0	47.0	46

<sup>1)</sup> Drying capacity is based on following moisture content test standards before and after drying:

- R134a: 1050 – 50 ppm W
- R404A, R507: 1020 – 50 ppm W
- R407C: 1020 – 50 ppm W
- R410A: 1050 – 50 ppm W
- R22: 1050 – 60 ppm W

In accordance with ARI 710-2004

<sup>2)</sup> Given in accordance with ARI 710-2004 for

- t<sub>e</sub> = -15 °C
- t<sub>c</sub> = 30 °C
- Δp = 0.07 bar

For technical data on other refrigerants, please contact your Danfoss Sales Representative

**Ordering**

Flare connection

**Type DMB flare**

Type	Connection		Multi pack	
	[in.]	[mm]	Qty.	Code no.
DMB 082	1/4	6	24	023Z1412
DMB 083	3/8	10	24	023Z1411
DMB 084	1/2	12	24	023Z1410
DMB 162	1/4	6	12	023Z1416
DMB 163	3/8	10	12	023Z1415
DMB 164	1/2	12	12	023Z1414
DMB 165	5/8	16	12	023Z1413
DMB 303	3/8	10	8	023Z1419
DMB 304	1/2	12	8	023Z1418
DMB 305	5/8	16	8	023Z1417



Flare connection

**Type DCB flare**

Type	Connection		Multi pack	
	[in.]	[mm]	Qty.	Code no.
DCB 082	1/4	6	24	023Z1402
DCB 083	3/8	10	24	023Z1401
DCB 084	1/2	12	24	023Z1400
DCB 162	1/4	6	12	023Z1406
DCB 163	3/8	10	12	023Z1405
DCB 164	1/2	12	12	023Z1404
DCB 165	5/8	16	12	023Z1403
DCB 303	3/8	10	8	023Z1409
DCB 304	1/2	12	8	023Z1408
DCB 305	5/8	16	8	023Z1407

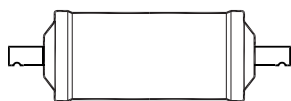
**Ordering  
(continued)**

Solder (pure copper connectors)

**Type DMB Solder (pure copper connectors)**

Type	Conn.	Multi pack		Industrial pack		Conn.	Multi pack	
	[in.]	Qty.	Code no.	Qty.	Code no.	[mm]	Qty.	Code no.
DMB 082s	1/4	24	023Z1443	–	–	–	–	–
DMB 083s	3/8	24	023Z1442	16	023Z1642	10	24	023Z1424
DMB 084s	1/2	24	023Z1441	16	023Z1641	–	–	–
DMB 163s	3/8	12	023Z1446	12	023Z1646	10	12	023Z1422
DMB 164s	1/2	12	023Z1445	–	–	–	–	–
DMB 165s	5/8	12	023Z1444	12	023Z1644	–	–	–
DMB 304s	1/2	8	023Z1449	–	–	–	–	–
DMB 305s	5/8	8	023Z1448	–	–	–	–	–
DMB 307s	7/8	8	023Z1447	–	–	–	–	–

**Type DCB Solder (pure copper connectors)**

Solder (pure copper connectors)

Type	Conn.	Multi pack		Industrial pack		Conn.	Multi pack	
	[in.]	Qty.	Code no.	Qty.	Code no.	[mm]	Qty.	Code no.
DCB 082s	1/4	24	023Z1434	–	–	–	–	–
DCB 083s	3/8	24	023Z1433	–	–	–	–	–
DCB 084s	1/2	24	023Z1432	–	–	–	–	–
DCB 163s	3/8	12	023Z1437	–	–	–	–	–
DCB 164s	1/2	12	023Z1436	12	023Z1636	–	–	–
DCB 165s	5/8	12	023Z1435	–	–	–	–	–
DCB 304s	1/2	8	023Z1440	–	–	–	–	–
DCB 305s	5/8	8	023Z1439	–	–	–	–	–
DCB 307s	7/8	8	023Z1438	–	–	–	–	–

Identification

Type codes

Type	Codes	Description
Filter drier	D	Drier
Solid core	C	80% Molecular Sieve / 20% activated alumina
	M	100% Molecular Sieve core
Application	B	Bi-flow
Filter housing volume (approx.)	08	8 in. <sup>3</sup>
	16	16 in. <sup>3</sup>
	30	30 in. <sup>3</sup>
Connection (filter connection in 1/8 of an inch increments)	2	1/4 in. / 6 mm
	3	3/8 in. / 10 mm
	4	1/2 in. / 12 mm
	5	5/8 in. / 16 mm
	7	7/8 in. / 22 mm
Connection type	(blank)	Flare connection
	s	Solder connection (pure copper connector)

Example for type codes

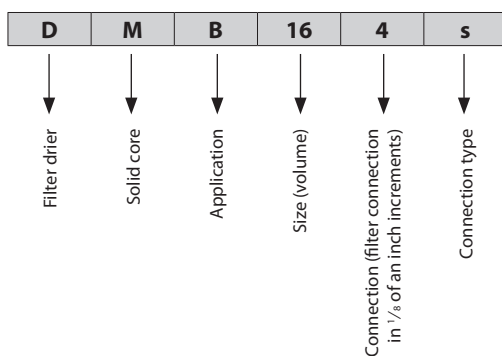

Construction / flow direction

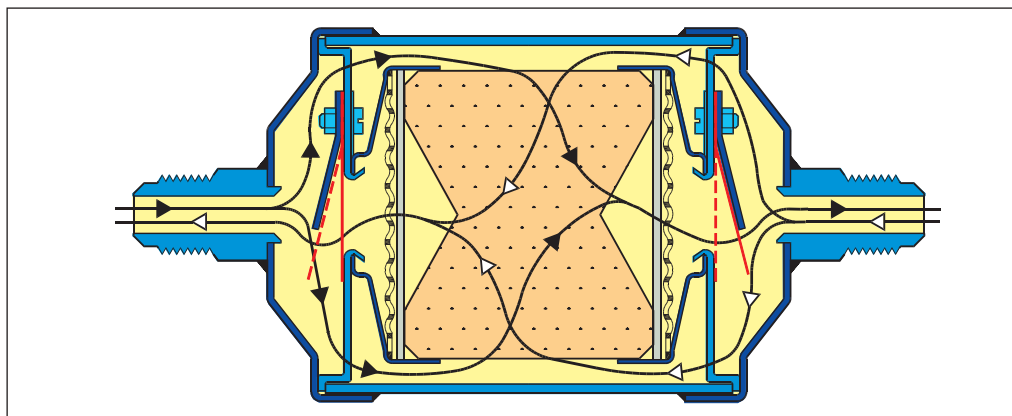

**Selection**

Type selection is made considering the application

Refrigerant and oil types		DCB	DMB
Refrigerant	HFO	Recommended	Recommended
	HC <sup>1)</sup>	Recommended	Recommended
	HFC	Recommended	Recommended
	HCFC	Recommended	Recommended
Oil	Mineral or AB	Recommended	Recommended
	POE or PAG, pure	Recommended	Recommended
	POE or PAG, with additives	Not recommended <sup>2)</sup>	Recommended

<sup>1)</sup> Only solder versions (cu-plated / pure copper) and connection sizes below 25 mm are approved for flammable refrigerants now

<sup>2)</sup> DCB Hermetic filter driers contain activated alumina, which is a polar material used for acid adsorption. Many oil additives are also polar substances and can be adsorbed by the activated alumina, rendering them useless, and reducing the drier's acid capacity, though this is not harmful to the system

**Selection example**

Select the appropriate type (DMB or DCB) based on refrigerant and oil type. Then select the drier size based on the adsorption and liquid capacity required.

c. Result

DMB 164 or DMB 165 can be used

If the initial moisture content is very small or a planned change of the filter drier considered, a smaller filter drier size can be chosen.

a. Amount of charge: 15 kg R134a at tL = 24 °C  
To dry 15 kg R134a at 24 °C from 1050 to 60 ppm moisture, a DMB 16 is necessary

b. Cooling capacity: Qe = 25 kW To obtain a mass flow corresponding to 25 kW cooling capacity with a DMB 16 filter drier, a ½ inch connection must be chosen. Larger connections can be chosen in accordance with the liquid line dimension

Type	Drying capacity [kg] refrigerant <sup>1)</sup>												Liquid capacity [kW] <sup>2)</sup>						Max. Working Pressure PS [bar]
	R134a		R404A		R507		R22		R407C		R410A		R134a	R404A	R507	R22	R407C	R410A	
	[°C]																		
	24	52	24	52	24	52	24	52	24	52	24	52							
DMB 082/082s	9.1	8.6	9.7	9.2	9.9	9.2	9.2	8.5	9.1	8.4	8.3	7.6	3.9	2.8	2.8	4.3	4.3	4.3	46
DMB 083/083s	9.1	8.6	9.7	9.2	9.9	9.2	9.2	8.5	9.1	8.4	8.3	7.6	7.4	5.3	5.3	8.2	8.2	8.2	46
DMB 084/084s	9.1	8.6	9.7	9.2	9.9	9.2	9.2	8.5	9.1	8.4	8.3	7.6	8.3	6.0	6.0	9.2	9.2	9.2	46
DMB 163/163s	17.1	16.2	18.4	17.4	18.7	17.3	17.3	16.0	17.1	15.8	15.6	14.4	18.0	13.0	13.0	20.0	20.0	20.0	46
DMB 164/164s	17.1	16.2	18.4	17.4	18.7	17.3	17.3	16.0	17.1	15.8	15.6	14.4	28.0	20.0	20.0	32.0	32.0	32.0	46
DMB 165/165s	17.1	16.2	18.4	17.4	18.7	17.3	17.3	16.0	17.1	15.8	15.6	14.4	37.0	29.0	29.0	40.0	40.0	40.0	46
DMB 303	42.0	39.7	45.2	42.8	46.0	42.5	42.5	39.3	42.1	38.9	38.3	35.3	19.0	15.0	15.0	21.0	21.0	21.0	46
DMB 304/304s	42.0	39.7	45.2	42.8	46.0	42.5	42.5	39.3	42.1	38.9	38.3	35.3	28.0	20.0	20.0	31.0	31.0	31.0	46
DMB 305/305s	42.0	39.7	45.2	42.8	46.0	42.5	42.5	39.3	42.1	38.9	38.3	35.3	38.0	28.0	28.0	42.0	42.0	42.0	46



**Dimensions and weights**

**Flare connections**

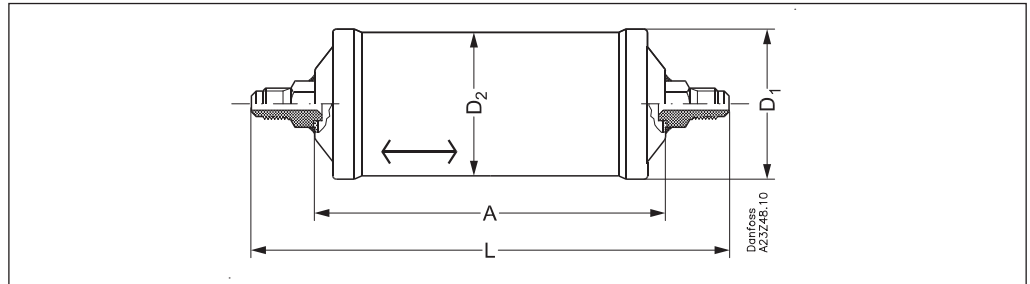

Type	A	L	D <sub>1</sub>	D <sub>2</sub>	Net weight
	[mm]	[mm]	[mm]	[mm]	[Kg]
DMB/DCB 082	103	147	58	54	0.5
DMB/DCB 083	103	160	58	54	0.5
DMB/DCB 084	103	168	58	54	0.6
DMB/DCB 162	112	156	80	76	0.8
DMB/DCB 163	112	169	80	76	0.8
DMB/DCB 164	112	177	80	76	0.9
DMB/DCB 165	112	186	80	76	0.9
DMB/DCB 303	188	245	80	76	1.1
DMB/DCB 304	188	253	80	76	1.2
DMB/DCB 305	188	262	80	76	1.2

**Solder connections (pure copper connectors)**

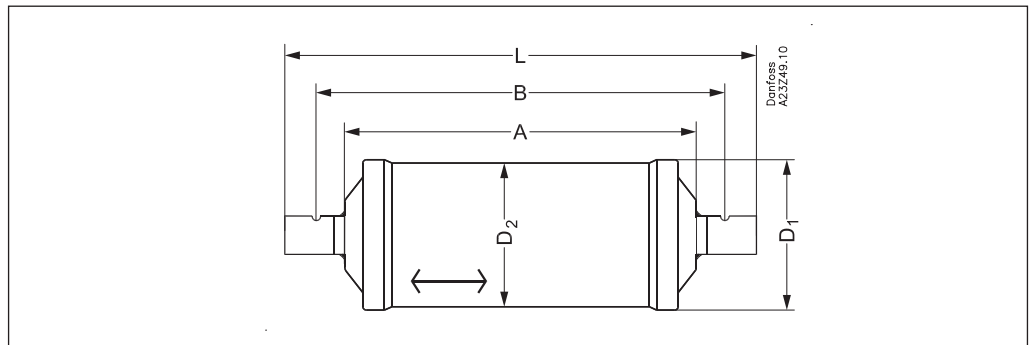

Type	A	B	L	D <sub>1</sub>	D <sub>2</sub>	Net weight
	[mm]	[mm]	[mm]	[mm]	[mm]	[Kg]
DMB/DCB 082s	103	119	135	58	54	0.5
DMB/DCB 083s	103	122	141	58	54	0.5
DMB/DCB 084s	103	124	145	58	54	0.6
DMB/DCB 163s	112	131	150	80	76	0.8
DMB/DCB 164s	112	133	154	80	76	0.8
DMB/DCB 165s	112	136	160	80	76	0.9
DMB/DCB 304s	188	209	230	80	76	1.0
DMB/DCB 305s	188	212	236	80	76	1.1
DMB/DCB 307s	188	214	250	80	76	1.1

Danfoss can accept no responsibility for possible errors in catalogues, brochures and other printed material. Danfoss reserves the right to alter its products without notice. This also applies to products already on order provided that such alterations can be made without consequential changes being necessary in specifications already agreed. All trademarks in this material are property of the respective companies. Danfoss and the Danfoss logotype are trademarks of Danfoss A/S. All rights reserved.