

User Guide

Temperature controller for limitation for the discharge gas temperature EKC 319A

ADAP-KOOL® Refrigeration control systems



Introduction

Application

The controller limits the pressure gas temperature in compressors by opening up for liquid injection in the suction line.

System

A temperature sensor will register the pressure gas temperature. If the temperature reaches the set temperature value, opening of the valve will be commenced. A PI regulation will adapt the opening degree of the valve so that the temperature will be limited.

Temperature sensor

Type AKS 21 can be used. It can stand the high temperature.

Valve

If the liquid injection is carried out directly in the suction line an expansion valve type AKV, or a type AKVA (for NH₃), is used. The capacity requirement is determined by the size of the valve. If the compressor is provided with a connection for liquid injection a pulse solenoid valve type EVRP is used in the liquid supply.

Alarm function

The controller will sound an alarm if the set alarm limit is exceeded. The alarm will activate the alarm relay.

Extra options

PC operation

The controller can be provided with data communication, so that it may be hooked up with other products in the ADAP-KOOL® range of refrigeration controls. Operation, monitoring and data collection can then be performed from a PC - either in situ or at a service company.

Literature survey:

Manual for EKC 319A.....RS8EB..
 Instructions for EKC 319A.....RI8HY..
 Installation guide, "Data communication link
 for ADAP-KOOL® ".....RC8AC..

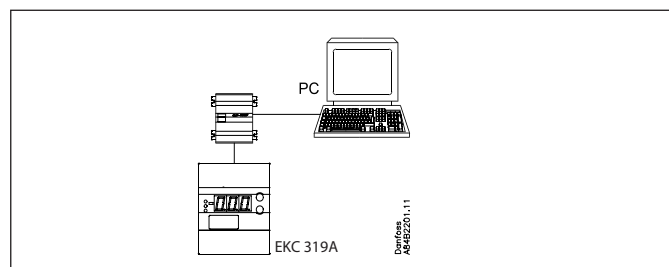
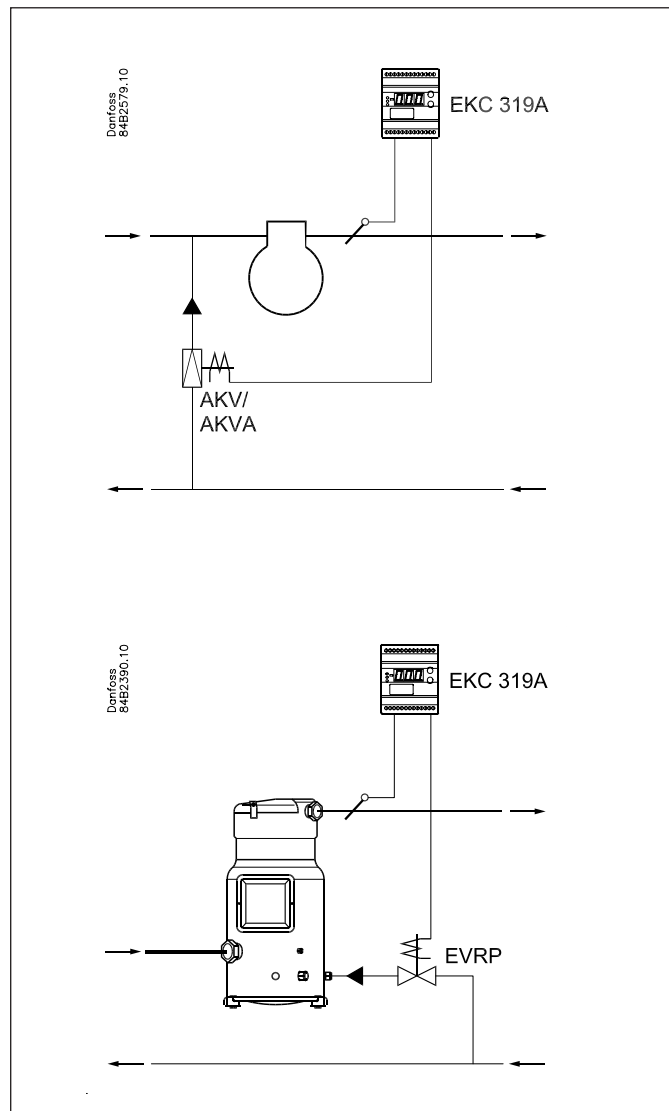

Survey of functions

Function	Parameter	Parameter by operation via data communication
Normal display		
The temperature sensor registers the discharge gas temperature. The value is shown in the display.	-	Temperature
The valve's actual opening degree can be displayed by giving the lower button a brief push (1s). Cf. also o17.	-	OD %
Reference		Temperature control
Reference The liquid injection starts when the set value is passed. Push both buttons simultaneously to set the setpoint.	-	Temperature Ref
Start/stop of regulation With this setting the regulation can be started and stopped. Start/stop can also be performed with the external contact function. Regulation is stopped if just one of them is OFF.	r12	Main Switch
Alarm		
The controller can give alarm in different situations. When there is an alarm the three lowest LED's at the front of the controller will flash, and the alarm relay is cut in. See also A19.		
Alarm limit A temperature limit can be set where the alarm is to be activated.	A16	Limit Alarm
Time delay for alarm When the temperature value is exceeded a timer function will start. The alarm will not become activated until the set time delay has been passed. The time delay is set in seconds.	A17	Limit Alm. delay
Activation of the alarm relay Set here whether the alarm relay is to be activated when the time delay has been passed: 0: Alarm relay active 1: Alarm relay not active	A19	Alarm type (With setting = 0 the alarm is also transmitted via the data communication)
		With data communication the importance of the individual alarms can be defined. Setting is carried out in the "Alarm destinations" menu.
Control parameters		Control Settings
P - band If the value is reduced the regulating range will be reduced. (The P-band will be over the reference).	n04	Kp factor
I: Integration time Tn The I-link can be made passive by setting the value at max. (600s) (If the Tn value is increased the regulation becomes slower).	n05	Tn sec.
Periode time The valve is operated with pulses of a given length. The length depends on the opening degree required. If a large opening degree is required, the pulse will last for an entire period time. A period time will thus comprise both open and closed valve.	n13	Period time
Miscellaneous		Miscellaneous
Address If the controller is built into a network with data communication, it must have an address, and the master gateway of the data communication must then know this address. These settings can only be made when a data communication module has been mounted in the controller and the installation of the data communication cable has been completed. This installation is mentioned in a separate document "RC8AC".		Following installation of a data communication module, the controller can be operated on a par with the other controllers in ADAP-KOOL® refrigeration controls.
The address is set between 1 and 60 (119)	o03	-
The address is sent to the gateway when the menu is set in pos. ON (The setting will automatically change back to Off after a few seconds.)	o04	-
Frequency Set the net frequency.	o12	50 / 60 Hz (50=0, 60=1)

<p>Selection of display The normal display can be defined to show either: 0: Discharge gas temperature 1: Opening degree of valve</p> <p>Later during the regulation: If the second display is to be read, the controller's lowermost button must be activated briefly. After five seconds the normal display will reappear.</p>	o17	Display
<p>Manual control of outputs In connection with service the alarm relay and the valve output can be put in pos. ON. But not until regulation has been stopped. OFF: No override 1: Valve output is ON 2. Alarm relay is activated (terminals 12 and 13 will be cut in)</p>	o18	-
Service		Service
A number of controller values can be printed for use in a service situation		
Read discharge gas temperature	u01	Temperature
Read the temperature reference	u02	Temperature ref
Read status of input DI (start/stop input)	u10	DI
Read valve's opening degree	u24	OD %
	--	DO1 limit alarm Read status of alarm relay ON is operating status with alarm
Operating status		
<p>Operating status of the controller can be called forth in the display. Push briefly (1s) the upper button. If there is a status code, it will be shown on the display. (Status codes have lower priority than alarm codes. In other words, you cannot see a status code, if there is an active alarm). The individual status codes have the following meanings:</p>		EKC Status (0 = regulation)
S10: The regulation stopped by the internal or external start/ stop		10

Operation

Display

The values will be shown with three digits, and after an operation the controller will return to its standard mode and show the measured discharge temperature.

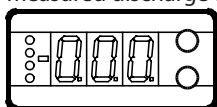

Light-emitting diodes (LED) on front panel

There are LED's on the front panel which will light up when the corresponding relay is activated.



The upper LED will indicate the valve's opening degree. A short pulse indicates a slow liquid flow and a long pulse a fast liquid flow.

The three lowest LED's will flash, if there is an error in the regulation.

In this situation you can upload the error code on the display and cancel the alarm by giving the uppermost button a brief push.

The buttons

When you want to change a setting, the two buttons will give you a higher or lower value depending on the button you are pushing. But before you change the value, you must have access to the menu. You obtain this by pushing the upper button for a couple of seconds - you will then enter the column with parameter codes. Find the parameter code you want to change and push the two buttons simultaneously. When you have changed the value, save the new value by once more pushing the two buttons simultaneously.

-  Gives access to the menu (or cutout an alarm)
-  Gives access to changes
-  Saves a change

Examples of operations

Set reference

1. Push the two buttons simultaneously
2. Push one of the buttons and select the new value
3. Push both buttons again to conclude the setting

Set one of the other menus

1. Push the upper button until a parameter is shown
2. Push one of the buttons and find the parameter you want to change
3. Push both buttons simultaneously until the parameter value is shown
4. Push one of the buttons and select the new value
5. Push both buttons again to conclude the setting

Error messages

The controller can give the following messages:		
E1	Error message	Errors in the controller
E17		The temperature sensor is disconnected
E18		The temperature sensor is shortcircuited
A3	Alarm message	Alarm temperature limit is reached

Menu survey

SW = 1.1x

Function	Parameter	Min.	Max.	Fac. setting
Normal display				
Read the measured discharge gas temperature	-		°C	
If you wish to see the actual opening degree, give the lower button a brief push	-		%	
If you wish to set the temperature reference you obtain access by pushing both buttons simultaneously	-	-70°C	160°C	125
Display / Control				
Select unit (0=°C, 1=°F)	r05	0	1	0
Start / stop of regulation	r12	OFF	ON/on	on
Alarm				
Alarm limit	A16	-50°C	150°C	135
Time delay for alarm	A17	0 s	999 s	0
Function of the alarm relay when the temperature exceed the alarm limit 0: Alarm relay active 1: Alarm relay not active	A19	0	1	1
Regulating parameters				
Proportionale factor Kp	n04	0,5	30	15
I: Integration time Tn	n05	60 s	600 s / Off	120
Periode time	n13	3 s	10 s	3
Miscellaneous				
Controller's address	o03*	0	119	-
ON/OFF switch (service-pin message)	o04*	OFF	ON	-
Set supply voltage frequency	o12	0/50 Hz	1/60 Hz	50
Select the showing of the "normal display": 0: Discharge gas temperature is shown 1: Valve's opening degree is shown	o17	0	1	0
Manual control of outputs: OFF: No manual control 1: Valve output put in pos. ON 2: Alarm relay activated (cut out)	o18	OFF	2	off
Service				
Read discharge gas temperature	u01		°C	
Read temperature reference	u02		°C	
Read status of input DI	u10			
Read valve's opening degree	u24		%	

*) This setting will only be possible if a data communication module has been installed in the controller.

Factory setting

If you need to return to the factory-set values, it can be done in this way:

- Cut out the supply voltage to the controller
- Keep both buttons depressed at the same time as you reconnect the supply voltage

Connections

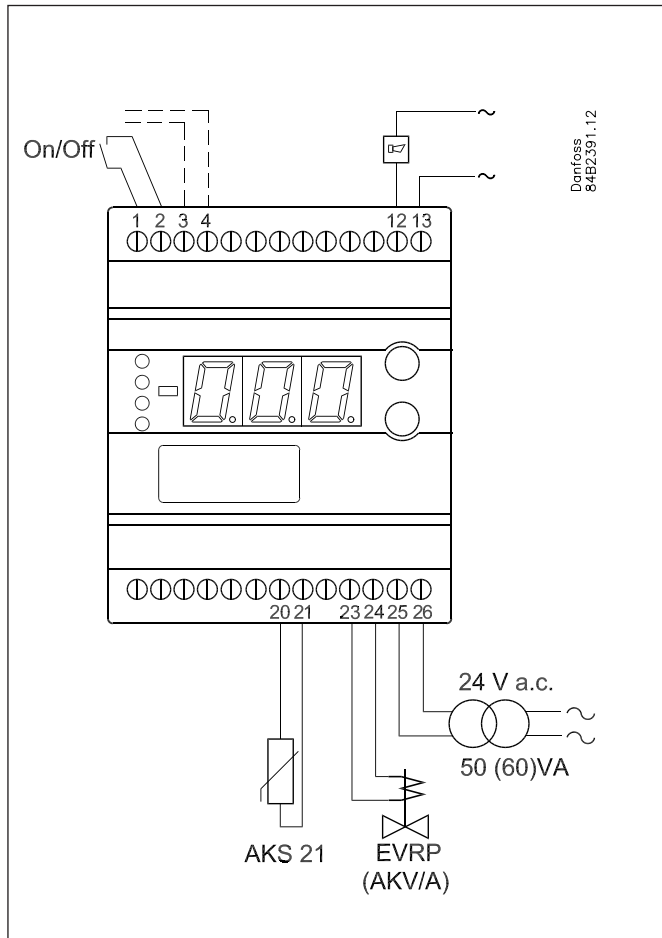

Data

Supply voltage	24 V a.c. +/-15% 50/60 Hz, 60 VA (the supply voltage is galvanically separated from the input and output signals. Input/output are not individual galvanic isolated)	
Power consumption	Controller 20 W coil for AKV / A Coil for EVRP	5 VA 55 VA 40 VA
Input signal	Temperature sensor	Pt 1000 ohm / 0°C
	Contact function start/stop of regulation	
Alarm relay	SPST	AC-1: 4 A (ohmic) AC-15: 3 A (inductive)
Valve connection	AKV, AKVA or EVRP via 24 a.c. Pulse-Width Modulating output	
Data communication	Possible to connect a data communication module	
Environments	0 - 55°C, during operation -40 - 70°C, during transport 20 - 80% Rh, not condensed No shock influence / vibrations	
Enclosure	IP 20	
Weight	300 g	
Montage	DIN Rail	
Display	LED, 3-digits	
Terminals	max. 2.5 mm ² multicore	
Approvals	EU Low Voltage Directive and EMC demands re CE-marking complied with. LVD-tested acc. to EN 60730-1 and EN 60730-2-9 EMC-tested acc. to EN50081-1 and EN 50082-2	

Necessary connections

Terminals:

- 25-26 Supply voltage 24 V a.c.
- 20-21 Signal from temperature sensor
- 23-24 Solenoid valve type EVRP / expansion valve type AKV or AKVA
- 1-2 Switch function for start/stop of regulation. If a switch is not connected, terminals 1 and 2 must be shortcircuited.

Application dependent connections

Terminal:

- 12-13 Alarm relay.
There is connection between 12 and 13 in alarm situations and when the supply voltage to the controller is interrupted
- 3-4 Data communication
Mount only, if a data communication module has been mounted.
It is important that the installation of the data communication cable be done correctly. Cf. separate literature No. RC8AC...

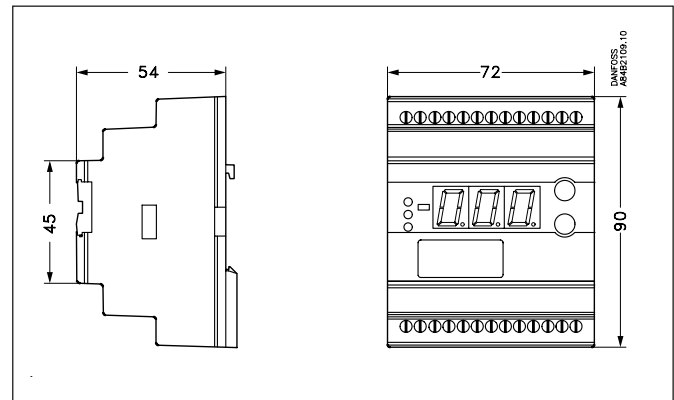

Ordering

Type	Function	Code no.
EKC 319A	Temperature controller	084B7251
EKA 173	Data communication module (accessories), (FTT 10 module)	084B7092
EKA 175	Data communication module (accessories), (RS 485 modul)	084B7093

Temperature sensor.....Kindly refer to catalogue RK0YG
AKV / AKVA Valves.....Kindly refer to catalogue RK0YG
EVRP valves.....Kindly refer to data sheet RD3KB

Data communication

This page contains a description of a few of the possibilities you will have when the controller is provided with data communication.

If you want to know more about operation of controllers via PC, you may order additional literature.

Examples

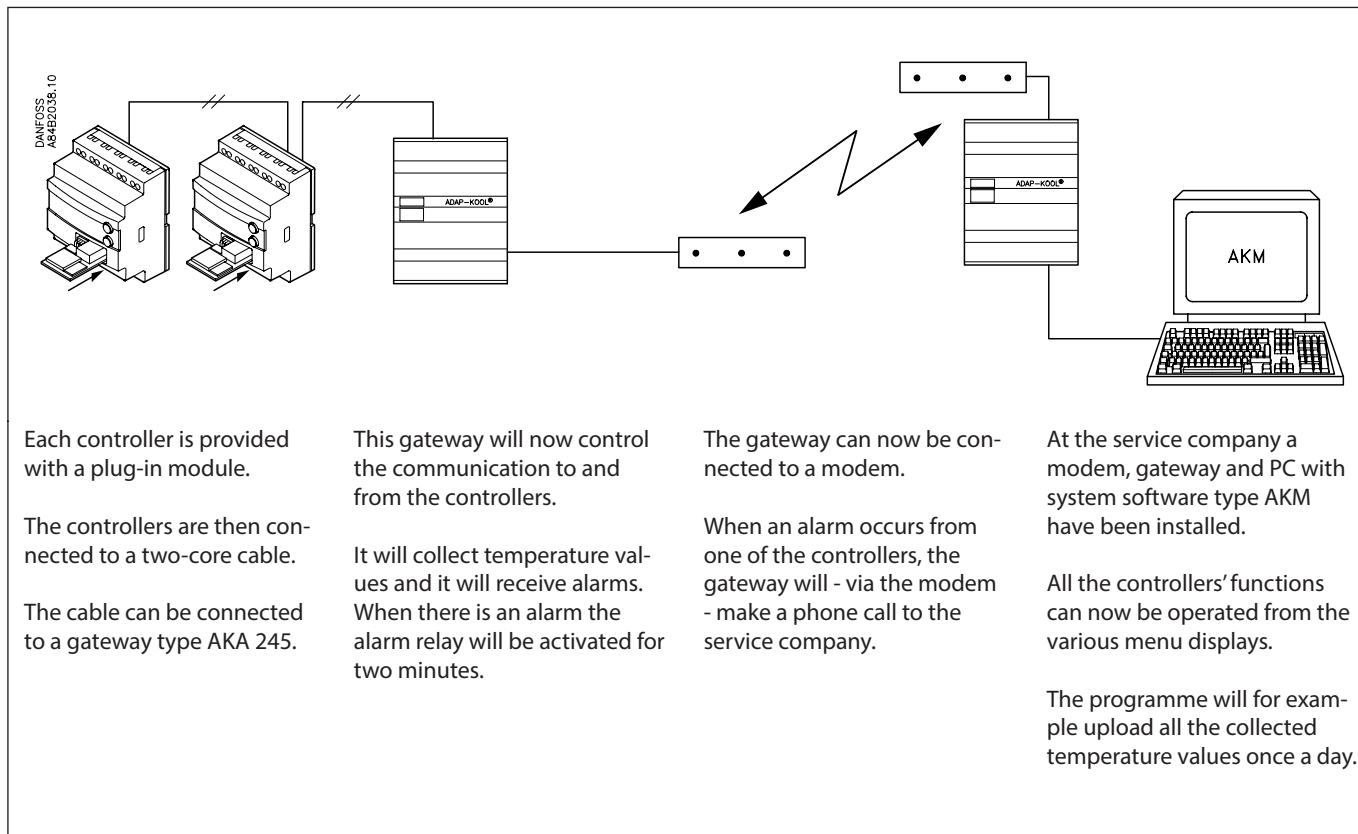

Example of menu display

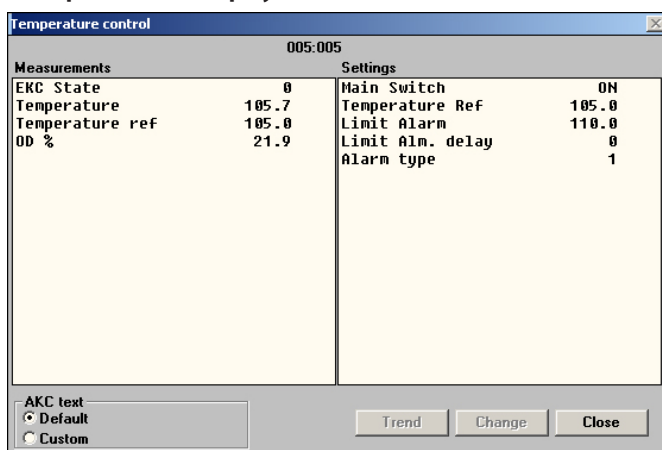

- Measurements are shown at one side and settings at the other.
- You will also be able to see the parameter names of the functions on page 3-4.
- With a simple change-over the values can also be shown in a trend diagram.
- If you wish to check earlier temperature measurements, you can see them in the log collection.

Alarms

If the controller is extended with data communication, it will be possible to define the importance of the transmitted alarms.

The importance is defined with the setting: 1, 2, 3 or 0. When the alarm then arises at some time, it will result in one of the following activities:

1 = Alarm
The alarm message is sent off with alarm status 1. This means that the gateway that is the master in the system will have its alarm relay output activated for two minutes. Later, when the alarm ceases, the alarm text will be retransmitted, but now with status value 0.

2 = Message
The alarm text is transmitted with status value 2. Later, when the "message" lapses, the alarm text is retransmitted, but now with status value 0.

3 = Alarm
As "1", but the master gateway's relay output is not activated.

0 = Suppressed information
The alarm text is stopped at the controller. It is transmitted nowhere.



The Product contains electrical components
And may not be disposed together with domestic waste.
Equipment must be separate collected with Electrical and Elec-
tronic waste. According to Local and currently valid legislation.