

Overview

The SITRANS P200 pressure transmitter measures the gauge and absolute pressure of liquids, gases and vapors.

- Ceramic measuring cell
- Gauge and absolute measuring ranges 1 to 60 bar (15 to 1000 psi)
- For general applications

Benefits

- High measuring accuracy
- Rugged stainless steel enclosure
- High overload withstand capability
- For aggressive and non-aggressive media
- For measuring the pressure of liquids, gases and vapors
- Compact design

Application

The SITRANS P200 pressure transmitter for gauge and absolute pressure is used in the following industrial areas:

- Mechanical engineering
- Shipbuilding
- Power engineering
- Chemical industry
- Water supply

Design**Device structure without explosion protection**

The pressure transmitter consists of a piezoresistive measuring cell with a diaphragm installed in a stainless steel enclosure. It can be used with a connector per EN 175301-803-A (IP65), a round plug M12 (IP67), a cable (IP67) or a Quickon cable quick screw connection (IP67) connected electrically. The output signal is between 4 and 20 mA or 0 and 10 V.

Device structure with explosion protection

The pressure transmitter consists of a piezoresistive measuring cell with a diaphragm installed in a stainless steel enclosure. It can be used with a connector per EN 175301-803-A (IP65) or a round plug M12 (IP67) connected electrically. The output signal is between 4 and 20 mA.

Function

The pressure transmitter measures the gauge and absolute pressure of liquids and gases as well as the level of liquids.

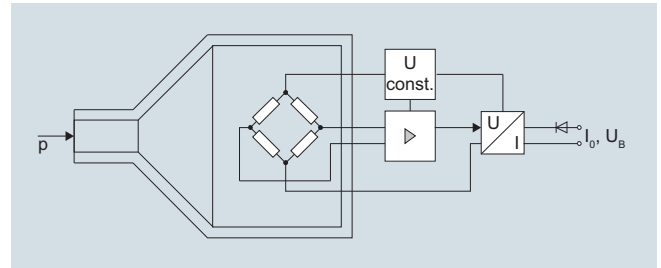
Mode of operation

SITRANS P200 pressure transmitters (7MF1565-...), functional diagram

The ceramic measuring cell has a thin-film resistance bridge to which the operating pressure p is transmitted through a ceramic diaphragm.

The voltage output from the measuring cell is converted by an amplifier into an output current of 4 to 20 mA or an output voltage of 0 to 10 V DC.

The output current and voltage are linearly proportional to the input pressure.

Pressure Measurement

Single-range transmitters for general applications

SITRANS P200 for gauge and absolute pressure

Technical specifications

Application	Liquids, gases and vapors
Gauge and absolute pressure measurement	
Mode of operation	
Measuring principle	Piezo-resistive measuring cell (ceramic diaphragm)
Measured variable	Gauge and absolute pressure
Inputs	
Measuring range	
• Gauge pressure	
- Metric	1 ... 60 bar (15 ... 870 psi)
- US measuring range	15 ... 1000 psi
• Absolute pressure	
- Metric	0.6 ... 16 bar a (10 ... 232 psia)
- US measuring range	10 ... 300 psia
Output	
Current signal	4 ... 20 mA
• Load	($U_B - 10$ V)/0.02 A
• Auxiliary power U_B	DC 7 ... 33 V (10 ... 30 V for Ex)
Voltage signal	0 ... 10 V DC
• Load	≥ 10 k Ω
• Auxiliary power U_B	12 ... 33 V DC
• Power consumption	< 7 mA at 10 k Ω
Ratiometric output	0 ... 90 %
• Load	≥ 10 k Ω
• Auxiliary power U_B	5 V DC \pm 10 %
• Power consumption	< 7 mA at 10 k Ω
Characteristic curve	Linear rising
Measuring accuracy	
Error in measurement at limit setting incl. hysteresis and reproducibility	<ul style="list-style-type: none"> • Typical: 0.25 % of full-scale value • Maximum: 0.5 % of full-scale value
Step response time T_{99}	< 5 ms
Long-term stability	
• Lower range value and measuring span	0.25 % of full-scale value/year
Influence of ambient temperature	
• Lower range value and measuring span	0.25 %/10 K of full-scale value
• Influence of power supply	0.005 %/V
Conditions of use	
Process temperature with gasket made of:	
• FPM (Standard)	-15 ... +125 °C (+5 ... +257 °F)
• Neoprene	-35 ... +100 °C (-31 ... +212 °F)
• Perbunan	-20 ... +100 °C (-4 ... +212 °F)
• EPDM	-40 ... +145 °C (-40 ... +293 °F), usable for drinking water
Ambient temperature	-25 ... +85 °C (-13 ... +185 °F)
Storage temperature	-50 ... +100 °C (-58 ... +212 °F)
Degree of protection (to EN 60529)	<ul style="list-style-type: none"> • IP 65 with connector per EN 175301-803-A • IP 67 with M12 connector • IP 67 with cable • IP 67 with cable quick screw connection
Electromagnetic compatibility	<ul style="list-style-type: none"> • acc. IEC 61326-1/-2/-3 • acc. NAMUR NE21, only for ATEX versions and with a max. measuring deviation ≤ 1 %

Design	
Weight	Approx. 0.090 kg (0.198 lb)
Process connections	See dimension drawings
Electrical connections	<ul style="list-style-type: none"> • Connector per EN 175301-803-A Form A with cable inlet M16x1.5 or 1/2-14 NPT or Pg 11 • M12 connector • 2 or 3-wire (0.5 mm²) cable ($\varnothing \pm 5.4$ mm) • Quickon cable quick screw connection
Wetted parts materials	
• Measuring cell	Al ₂ O ₃ - 96 %
• Process connection	Stainless steel, mat. No. 1.4404 (SST 316 L)
• Gasket	<ul style="list-style-type: none"> • FPM (Standard) • Neoprene • Perbunan • EPDM
Non-wetted parts materials	
• Enclosure	Stainless steel, mat. No. 1.4404 (SST 316 L)
• Rack	Plastic
• Cables	PVC
Certificates and approvals	
Classification according to pressure equipment directive (PED 2014/68/EU)	For gases of fluid group 1 and liquids of fluid group 1; complies with requirements of article 4, paragraph 3 (sound engineering practice)
Lloyd's Register of Shipping (LR) ¹⁾	12/20010
Germanischer Lloyd (GL) ¹⁾	GL19740 11 HH00
American Bureau of Shipping (ABS) ¹⁾	ABS_11_HG 789392_PDA
Bureau Veritas (BV) ¹⁾	BV 271007A0 BV
Det Norske Veritas (DNV) ¹⁾	A 12553
Drinking water approval (ACS) ¹⁾	ACS 15 ACC NY 360
EAC ¹⁾	№ TC RU C-DE.ГБ05.В.00732 OC НАМИО «ЛЦБЭ»
Underwriters Laboratories (UL) ¹⁾	
• for USA and Canada	UL 20110217 - E34453
• worldwide	IEC UL DK 21845
Explosion protection	
Intrinsic safety "i" (only with current output)	Ex II 1/2 G Ex ia IIC T4 Ga/Gb Ex II 1/2 D Ex ia IIIC T125 °C Da/Db
EC type-examination certificate	SEV 10 ATEX 0146
Connection to certified intrinsically-safe resistive circuits with maximum values:	$U_i \leq 30$ V DC; $I_i \leq 100$ mA; $P_i \leq 0.75$ W
Effective internal inductance and capacity for versions with plugs per EN 175301-803-A and M12	$L_i = 0$ nH; $C_i = 0$ nF
¹⁾ For variants with output signal 0 ... 5 V and ratiometric output available soon.	

Pressure Measurement

Single-range transmitters for general applications

SITRANS P200 for gauge and absolute pressure

1

Selection and ordering data

SITRANS P 200 pressure transmitters for pressure and absolute pressure for general applications

Characteristic curve deviation typ. 0.25 %

Wetted parts materials: Ceramic and stainless steel + sealing material

Non-wetted parts materials: stainless steel

[Click on the Article No. for the online configuration in the PIA Life Cycle Portal.](#)

Article No.

Order code

7MF1565 -

Measuring range		Overload limit		Burst pressure		Article No.	Order code
		Min.	Max.				
For gauge pressure							
0 ... 1 bar	(0 ... 14.5 psi)	-1 bar (-14.5 psi)	2.5 bar (36.26 psi)	> 2.5 bar (> 36.3 psi)	▶◆	7MF1565 -	3 BA
0 ... 1.6 bar	(0 ... 23.2 psi)	-1 bar (-14.5 psi)	4 bar (58.02 psi)	> 4 bar (> 58.0 psi)	▶◆		3 BB
0 ... 2.5 bar	(0 ... 36.3 psi)	-1 bar (-14.5 psi)	6.25 bar (90.65 psi)	> 6.25 bar (> 90.7 psi)	▶◆		3 BD
0 ... 4 bar	(0 ... 58.0 psi)	-1 bar (-14.5 psi)	10 bar (145 psi)	> 10 bar (> 145 psi)	▶◆		3 BE
0 ... 6 bar	(0 ... 87.0 psi)	-1 bar (-14.5 psi)	15 bar (217 psi)	> 15 bar (> 217 psi)	▶◆		3 BG
0 ... 10 bar	(0 ... 145 psi)	-1 bar (-14.5 psi)	25 bar (362 psi)	> 25 bar (> 362 psi)	▶◆		3 CA
0 ... 16 bar	(0 ... 232 psi)	-1 bar (-14.5 psi)	40 bar (580 psi)	> 40 bar (> 580 psi)	▶◆		3 CB
0 ... 25 bar	(0 ... 363 psi)	-1 bar (-14.5 psi)	62.5 bar (906 psi)	> 62.5 bar (> 906 psi)	▶◆		3 CD
0 ... 40 bar	(0 ... 580 psi)	-1 bar (-14.5 psi)	100 bar (1450 psi)	> 100 bar (> 1450 psi)	▶◆		3 CE
0 ... 60 bar	(0 ... 870 psi)	-1 bar (-14.5 psi)	150 bar (2175 psi)	> 150 bar (> 2175 psi)	▶◆		3 CG
Other version, add Order code and plain text: Measuring range: ... up to... bar (psi)						9 AA	H 1 Y
For absolute pressure							
0 ... 0.6 bar a	(0 ... 8.7 psia)	0 bar a (0 psia)	2.5 bar a (36.26 psia)	> 2.5 bar a (> 36.3 psia)	▶◆		5 AG
0 ... 1 bar a	(0 ... 14.5 psia)	0 bar a (0 psia)	2.5 bar a (36.26 psia)	> 2.5 bar a (> 36.3 psia)	▶◆		5 BA
0 ... 1.6 bar a	(0 ... 23.2 psia)	0 bar a (0 psia)	4 bar a (58.02 psia)	> 4 bar a (> 58.0 psia)	▶◆		5 BB
0 ... 2.5 bar a	(0 ... 36.3 psia)	0 bar a (0 psia)	6.25 bar a (90.65 psia)	> 6.25 bar a (> 90.7 psia)	▶◆		5 BD
0 ... 4 bar a	(0 ... 58.0 psia)	0 bar a (0 psia)	10 bar a (145 psia)	> 10 bar a (> 145 psia)	▶◆		5 BE
0 ... 6 bar a	(0 ... 87.0 psia)	0 bar a (0 psia)	15 bar a (217 psia)	> 15 bar a (> 217 psia)	▶◆		5 BG
0 ... 10 bar a	(0 ... 145 psia)	0 bar a (0 psia)	25 bar a (362 psia)	> 25 bar a (> 362 psia)	▶◆		5 CA
0 ... 16 bar a	(0 ... 232 psia)	0 bar a (0 psia)	40 bar a (580 psia)	> 40 bar a (> 580 psia)	▶◆		5 CB
Other version, add Order code and plain text: Measuring range: ... up to ... mbar a (psia)						9 AA	H 2 Y
Measuring ranges for gauge pressure							
0 ... 15 psi		-14.5 psi	35 psi	> 35 psi			4 BB
3 ... 15 psi		-14.5 psi	35 psi	> 35 psi			4 BC
0 ... 20 psi		-14.5 psi	50 psi	> 50 psi			4 BD
0 ... 30 psi		-14.5 psi	80 psi	> 80 psi			4 BE
0 ... 60 psi		-14.5 psi	140 psi	> 140 psi			4 BF
0 ... 100 psi		-14.5 psi	200 psi	> 200 psi			4 BG
0 ... 150 psi		-14.5 psi	350 psi	> 350 psi			4 CA
0 ... 200 psi		-14.5 psi	550 psi	> 550 psi			4 CB
0 ... 300 psi		-14.5 psi	800 psi	> 800 psi			4 CD
0 ... 500 psi		-14.5 psi	1400 psi	> 1400 psi			4 CE
0 ... 750 psi		-14.5 psi	2000 psi	> 2000 psi			4 CF
0 ... 1000 psi		-14.5 psi	2000 psi	> 2000 psi			4 CG
Other version, add Order code and plain text: Measuring range: ... up to ... psi						9 AA	H 1 Y
Measuring ranges for absolute pressure							
0 ... 10 psia		0 psia	35 psia	> 35 psia			6 AG
0 ... 15 psia		0 psia	35 psia	> 35 psia			6 BA
0 ... 20 psia		0 psia	50 psia	> 50 psia			6 BB
0 ... 30 psia		0 psia	80 psia	> 80 psia			6 BD
0 ... 60 psia		0 psia	140 psia	> 140 psia			6 BE
0 ... 100 psia		0 psia	200 psia	> 200 psia			6 BG
0 ... 150 psia		0 psia	350 psia	> 350 psia			6 CA
0 ... 200 psia		0 psia	550 psia	> 550 psia			6 CB
0 ... 300 psia		0 psia	800 psia	> 800 psia			6 CC
Other version, add Order code and plain text: Measuring range: ... up to ... psia						9 AA	H 2 Y

▶ Available ex stock

◆ We can offer shorter delivery times for configurations designated with the Quick Ship Symbol ◆. For details see page 10/1110/11 in the appendix.

Pressure Measurement

Single-range transmitters for general applications

SITRANS P200 for gauge and absolute pressure

1

Selection and ordering data	Article No.	Order code
SITRANS P 200 pressure transmitters for pressure and absolute pressure for general applications Accuracy typ. 0.25 % Wetted parts materials: Ceramic and stainless steel + sealing material Non-wetted parts materials: stainless steel	7MF1565-	
Output signal 4 ... 20 mA; two-wire system; power supply 7 ... 33 V DC (10 ... 30 V DC for ATEX versions) ▶◆ 0 ... 10 V; three-wire system; power supply 12 ... 33 V DC 0 ... 5 V; 3-wire system; auxiliary power 7 ... 33 V DC Ratiometric 10 ... 90 %; 3-wire system; auxiliary power 5 V DC ± 10 %		0 10 20 30
Explosion protection (only 4 ... 20 mA) None ▶◆ With explosion protection Ex ia IIC T4 ▶◆		0 1
Electrical connection Connector per DIN EN 175301-803-A, stuffing box thread M16 (with coupling) ▶◆ Round connector M12 per IEC 61076-2-101 Connection via fixed mounted cable, 2 m (not for type of protection "Intrinsic safety i") Quickon cable quick screw connection PG9 (not for type of protection "Intrinsic safety i") Connector per DIN EN 175301-803-A, stuffing box thread 1/2"-14 NPT (with coupling) Connector per DIN EN 175301-803-A, stuffing box thread PG11 (with coupling) Fixed mounted cable, length 5 m Special version		1 2 03 04 5 6 07 9 N1Y
Process connection G1/2" male per EN 837-1 (1/2" BSP male) (standard for metric pressure ranges mbar, bar) ▶◆ G1/2" male thread and G1/8" female thread G1/4" male per EN 837-1 (1/4" BSP male) 7/16"-20 UNF male 1/4"-18 NPT male (standard for pressure ranges inH ₂ O and psi) 1/4"-18 NPT female 1/2"-14 NPT male 1/2"-14 NPT female 7/16"-20 UNF female M20x1.5 male G1/4" to DIN 3852 Form E G1/2" to DIN 3852 Form E Special version		A B C D E F G H J P Q R Z P1Y
Sealing material between sensor and enclosure Viton (FPM, standard) ▶◆ Neoprene (CR) Perbunan (NBR) EPDM Special version		A B C D Z Q1Y
Version Standard version ▶◆		1
Further designs Supplement the Article No. with "-Z" and add Order code. Quality Inspection Certificate (5-point characteristic curve test) according to IEC 60770-2 Oxygen version, free of oil and degreased, max. operating pressure 60 bar, max. process temperature +85 °C (only in conjunction with the sealing material Viton between sensor and enclosure and not with explosion protection version)	C11 E10	

▶ Available ex stock

◆ We can offer shorter delivery times for configurations designated with the Quick Ship Symbol ◆. For details see page 10/11 in the appendix.

Dimensional drawings

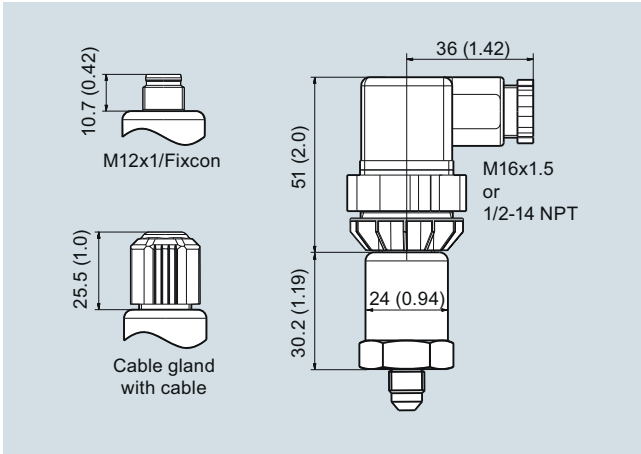

SITRANS P200, electrical connections, dimensions in mm (inch)

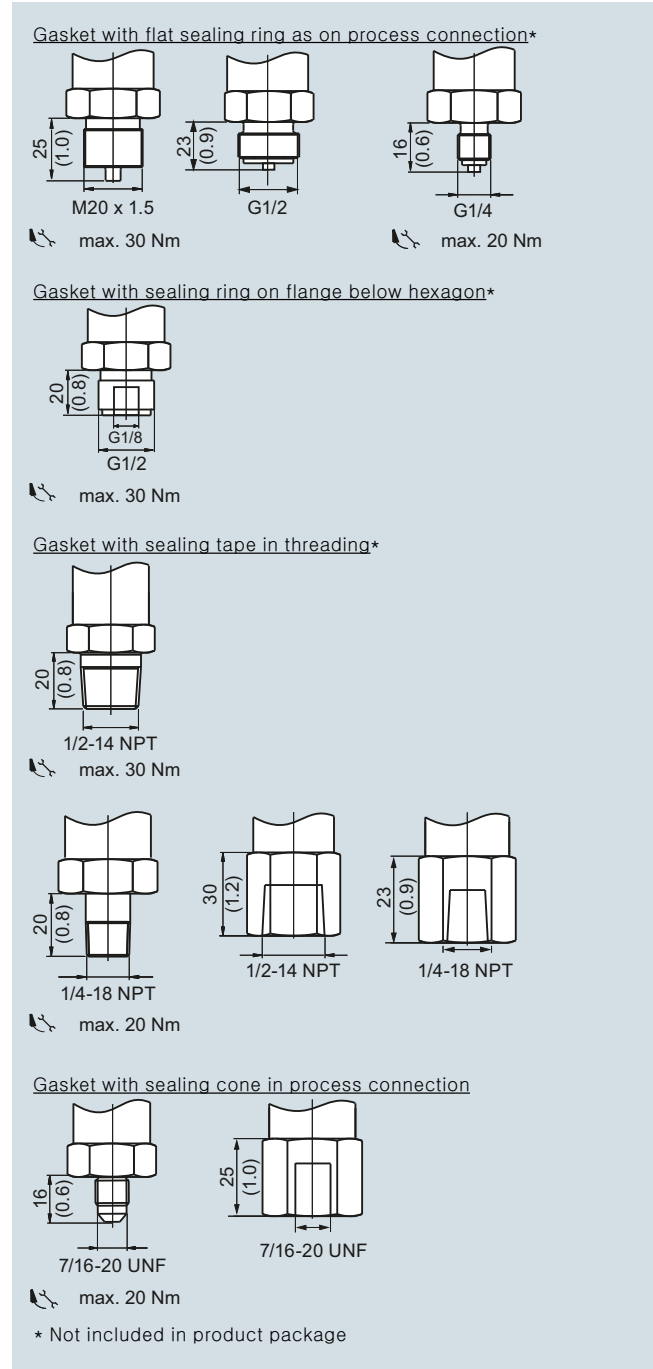

SITRANS P200, process connections, dimensions in mm (inch)

Pressure Measurement

Single-range transmitters for general applications

SITRANS P200 for gauge and absolute pressure

Schematics

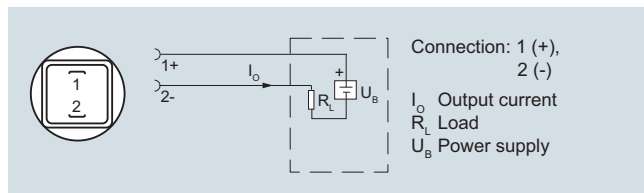

Connection with current output and connector per EN 175301

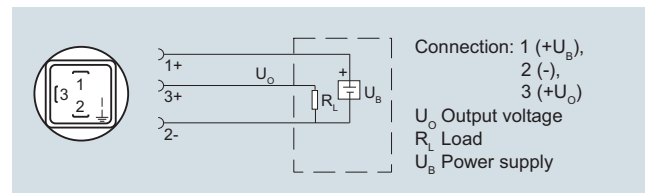

Connection with voltage output, ratiometric output and plug according to EN 175301

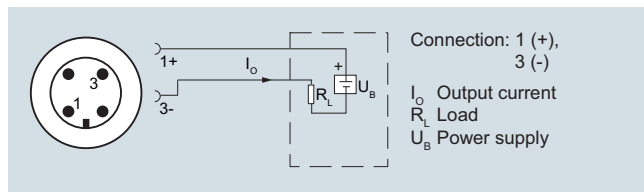

Connection with current output and connector M12x1

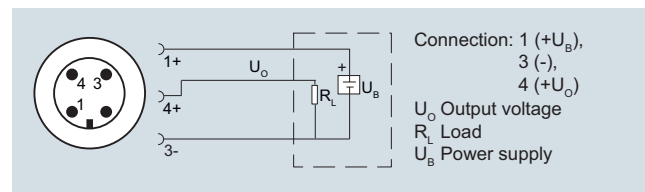

Connection with voltage output, ratiometric output and M12x1 plug

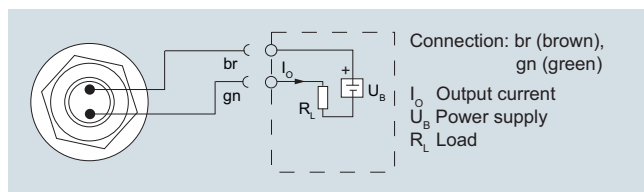

Connection with current output and cable

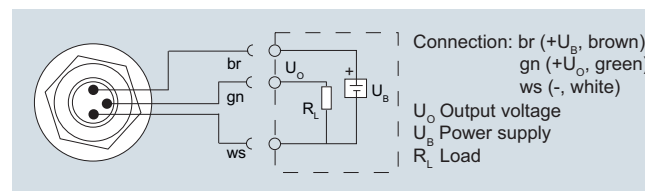

Connection with voltage output, ratiometric output and cable

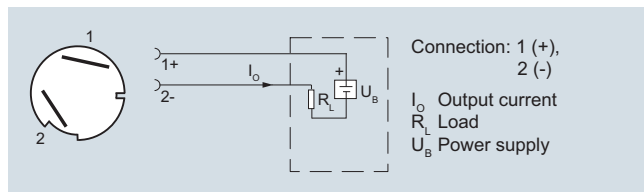

Connection with current output and Quickon cable quick screw connection

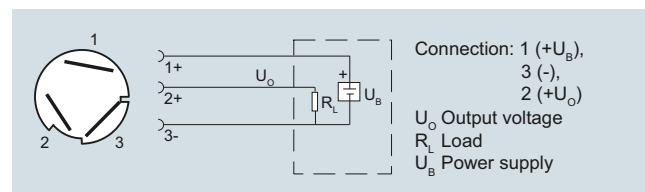

Connection with voltage output, ratiometric output and Quickon fast cable termination

Version with explosion protection: 4 ... 20 mA

The grounding connection is conductively bonded to the transmitter enclosure

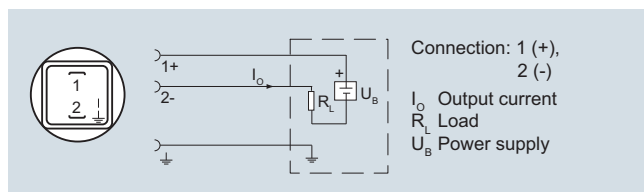

Connection with current output and connector per EN 175301 (Ex)

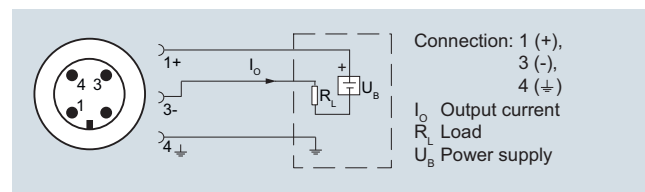

Connection with current output and connector M12x1 (Ex)

Overview

The pressure transmitter SITRANS P210 measures the gauge pressure of liquids, gases and vapors.

- Stainless steel measuring cell
- Measuring ranges 100 to 600 mbar (1.45 to 8.7 psi) relative
- For low-pressure applications

Benefits

- High measuring accuracy
- Rugged stainless steel enclosure
- High overload withstand capability
- For aggressive and non-aggressive media
- For measuring the pressure of liquids, gases and vapors
- Compact design

Application

The pressure transmitter SITRANS P210 for gauge pressure is used in the following industrial areas:

- Mechanical engineering
- Shipbuilding
- Power engineering
- Chemical industry
- Water supply

Design**Device structure without explosion protection**

The pressure transmitter consists of a piezoresistive measuring cell with a diaphragm installed in a stainless steel enclosure. It can be used with a connector per EN 175301-803-A (IP65), a round plug M12 (IP67), a cable (IP67) or a Quickon cable quick screw connection (IP67) connected electrically. The output signal is between 4 and 20 mA or 0 and 10 V.

Device structure with explosion protection

The pressure transmitter consists of a piezoresistive measuring cell with a diaphragm installed in a stainless steel enclosure. It can be used with a connector per EN 175301-803-A (IP65) or a round plug M12 (IP67) connected electrically. The output signal is between 4 and 20 mA.

Function

The pressure transmitter measures the gauge pressure of liquids and gases as well as the level of liquids.

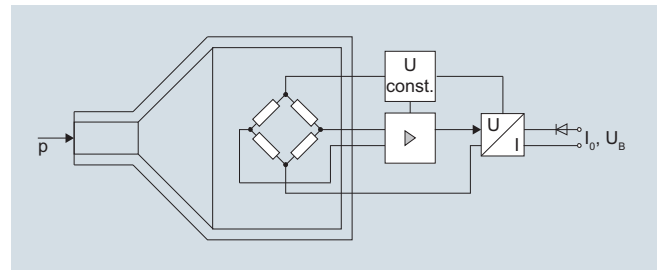
Mode of operation

SITRANS P210 pressure transmitters (7MF1566-...), functional diagram

The stainless steel measuring cell has a thin-film resistance bridge to which the operating pressure p is transmitted through a stainless steel diaphragm.

The voltage output from the measuring cell is converted by an amplifier into an output current of 4 to 20 mA or an output voltage of 0 to 10 V DC.

The output current and voltage are linearly proportional to the input pressure.

Pressure Measurement

Single-range transmitters for general applications

SITRANS P210 for gauge pressure

1

Technical specifications

Application	Gauge measurement	Liquids, gases and vapors
Mode of operation	Measuring principle	Piezoresistive measuring cell (stainless steel diaphragm)
Measured variable		Gauge pressure
Inputs	Measuring range	100 ... 600 mbar (1.5 ... 8.7 psi)
• Gauge pressure		
Output	Current signal	4 ... 20 mA (U _B - 10 V)/0.02 A
• Load		
• Auxiliary power U _B		DC 7 ... 33 V (10 ... 30 V for Ex)
Voltage signal		0 ... 10 V DC
• Load		≥ 10 kΩ
• Auxiliary power U _B		12 ... 33 V DC
• Power consumption		< 7 mA at 10 kΩ
Ratiometric output		0 ... 90 %
• Load		≥ 10 kΩ
• Auxiliary power U _B		5 V DC ± 10 %
• Power consumption		< 7 mA at 10 kΩ
Characteristic curve		Linear rising
Measuring accuracy	Error in measurement at limit setting incl. hysteresis and reproducibility	<ul style="list-style-type: none"> • Typical: 0.25 % of full-scale value • Maximum: 0.5 % of full-scale value
Step response time T ₉₉		< 5 ms
Long-term stability		0.25 % of full-scale value/year span
• Lower range value and measuring span		
Influence of ambient temperature		0.25 %/10 K of full-scale value
• Lower range value and measuring span		0.5 %/10K of full-scale value for a measuring range 100 ... 400 mbar
• Influence of power supply		0.005 %/V
Conditions of use	Process temperature with gasket made of:	
• FPM (Standard)		-15 ... +125 °C (+5 ... +257 °F)
• Neoprene		-35 ... +100 °C (-31 ... +212 °F)
• Perbunan		-20 ... +100 °C (-4 ... +212 °F)
• EPDM		-40 ... +145 °C (-40 ... +293 °F), usable for drinking water
Ambient temperature		-25 ... +85 °C (-13 ... +185 °F)
Storage temperature		-50 ... +100 °C (-58 ... +212 °F)
Degree of protection (to EN 60529)		<ul style="list-style-type: none"> • IP 65 with connector per EN 175301-803-A • IP 67 with M12 connector • IP 67 with cable • IP 67 with cable quick screw connection
Electromagnetic compatibility		<ul style="list-style-type: none"> • acc. IEC 61326-1/-2/-3 • acc. NAMUR NE21, only for ATEX versions and with a max. measuring deviation ≤ 1 %
Mounting position		upright

Design	Weight	Approx. 0.090 kg (0.198 lb)
Process connections		See dimension drawings
Electrical connections		<ul style="list-style-type: none"> • Connector per EN 175301-803-A Form A with cable inlet M16x1.5 or ½-14 NPT or Pg 11 • M12 connector • 2 or 3-wire (0.5 mm²) cable (∅ ± 5.4 mm) • Quickon cable quick screw connection
Wetted parts materials		
• Measuring cell		Stainless steel, mat.-No. 1.4435
• Process connection		Stainless steel, mat. No. 1.4404 (SST 316 L)
• Gasket		<ul style="list-style-type: none"> • FPM (Standard) • Neoprene • Perbunan • EPDM
Non-wetted parts materials		
• Enclosure		Stainless steel, mat. No. 1.4404 (SST 316 L)
• Rack		Plastic
• cables		PVC
Certificates and approvals	Classification according to pressure equipment directive (PED 2014/68/EU)	For gases of fluid group 1 and liquids of fluid group 1; meets requirements as per article 4, paragraph 3 (good engineering practice)
Lloyd's Register of Shipping (LR) ¹⁾		12/20010
Germanischer Lloyd (GL) ¹⁾		GL19740 11 HH00
American Bureau of Shipping (ABS) ¹⁾		ABS_11_HG 789392_PDA
Bureau Veritas (BV) ¹⁾		BV 271007A0 BV
Det Norske Veritas (DNV) ¹⁾		A 12553
Drinking water approval (ACS) ¹⁾		ACS 15 ACC NY 360
EAC ¹⁾		№ TC RU C-DE.ГБ05.В.00732 OC НАННО «ЦСВЭ»
Underwriters Laboratories (UL) ¹⁾		
• for USA and Canada		UL 20110217 - E34453
• worldwide		IEC UL DK 21845
Explosion protection	Intrinsic safety "i" (only with current output)	Ex II 1/2 G Ex ia IIC T4 Ga/Gb Ex II 1/2 D Ex ia IIIC T125 °C Da/Db
EC type-examination certificate		SEV 10 ATEX 0146
Connection to certified intrinsically-safe resistive circuits with maximum values:		U _i ≤ 30 V DC; I _i ≤ 100 mA; P _i ≤ 0.75 W
Effective internal inductance and capacity for versions with plugs per EN 175301-803-A and M12		L _i = 0 nH; C _i = 0 nF
<p>¹⁾ For variants with output signal 0 ... 5 V and ratiometric output available soon.</p>		

Pressure Measurement

Single-range transmitters for general applications

SITRANS P210 for gauge pressure

1

Selection and ordering data

SITRANS P 210 pressure transmitters for gauge pressure for low pressure applications

Accuracy typ. 0.25 %

Wetted parts materials: Stainless steel + sealing material

Non-wetted parts materials: stainless steel

➤ Click on the Article No. for the online configuration in the PIA Life Cycle Portal.

Measuring range					Overload limit		Burst pressure		Article No.	Order code
					min.	max.				
For gauge pressure										
0...100 mbar	(1.45 psi)	-400 mbar	(-5.8 psi)	400 mbar	(5.8 psi)	1 bar	(14.5 psi)	▶◆	7MF1566-	3AA
0...160 mbar	(2.32 psi)	-400 mbar	(-5.8 psi)	400 mbar	(5.8 psi)	1 bar	(14.5 psi)	▶◆		3AB
0...250 mbar	(3.63 psi)	-800 mbar	(-11.6 psi)	1000 mbar	(14.5 psi)	2 bar	(29.0 psi)	▶◆		3AC
0...400 mbar	(5.8 psi)	-800 mbar	(-11.6 psi)	1000 mbar	(14.5 psi)	2 bar	(29.0 psi)	▶◆		3AD
0...600 mbar	(8.7 psi)	-1000 mbar	(-14.5 psi)	2000 mbar	(29.0 psi)	3 bar	(43.5 psi)	▶◆		3AG
Other version, add Order code and plain text: Measuring range: ... up to ... mbar (psi)										9AA
Output signal										
4 ... 20 mA; two-wire system; power supply 7 ... 33 V DC (10 ... 30 V DC for ATEX versions)									▶◆	0
0 ... 10 V; three-wire system; power supply 12 ... 33 V DC										10
0 ... 5 V; 3-wire system; auxiliary power 7 ... 33 V DC										20
Ratiometric 10 ... 90 %; 3-wire system; auxiliary power 5 V DC ± 10 %										30
Explosion protection (only 4 ... 20 mA)										
None									▶◆	0
With explosion protection Ex ia IIC T4									▶◆	1
Electrical connection										
Connector per DIN EN 175301-803-A, stuffing box thread M16 (with coupling)									▶◆	1
Round connector M12 per IEC 61076-2-101										2
Connection via fixed mounted cable, 2 m (not for type of protection "Intrinsic safety i")										03
Quickon cable quick screw connection PG9 (not for type of protection "Intrinsic safety i")										04
Connector per DIN EN 175301-803-A, stuffing box thread 1/2"-14 NPT (with coupling)										5
Connector per DIN EN 175301-803-A, stuffing box thread PG11 (with coupling)										6
Fixed mounted cable, length 5 m										07
Special version										9
Process connection										
G1/2" male per EN 837-1 (1/2" BSP male) (standard for metric pressure ranges mbar, bar)									▶◆	A
G1/2" male thread and G1/8" female thread										B
G1/4" male per EN 837-1 (1/4" BSP male)										C
7/16"-20 UNF male										D
1/4"-18 NPT male (standard for pressure ranges inH ₂ O and psi)										E
1/4"-18 NPT female										F
1/2"-14 NPT male										G
1/2"-14 NPT female										H
7/16"-20 UNF female										J
M20x1.5 male										P
G1/4" to DIN 3852 Form E										Q
G1/2" to DIN 3852 Form E										R
Special version										Z
Sealing material between sensor and enclosure										
Viton (FPM, standard)									▶◆	A
Neoprene (CR)										B
Perbunan (NBR)										C
EPDM										D
Special version										Z
Version										
Standard version									▶◆	1

Further designs

Supplement the Article No. with "-Z" and add Order code.

Quality Inspection Certificate (5-point characteristic curve test) according to IEC 60770-2

▶ Available ex stock

◆ We can offer shorter delivery times for configurations designated with the Quick Ship Symbol ◆. For details see page 10/11 in the appendix.

C11

Pressure Measurement

Single-range transmitters for general applications

SITRANS P210 for gauge pressure

1

Dimensional drawings

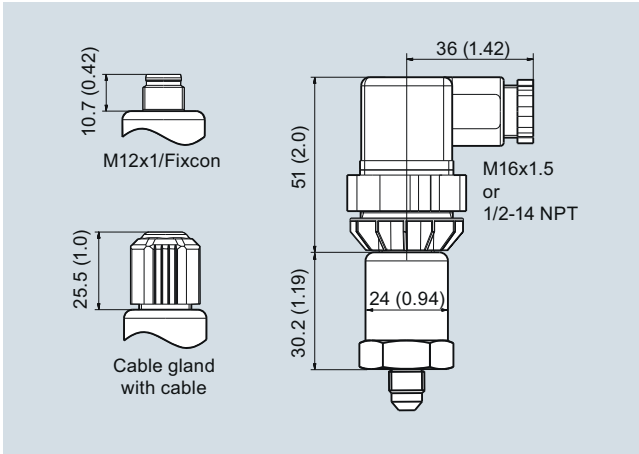

SITRANS P210, electrical connections, dimensions in mm (inch)

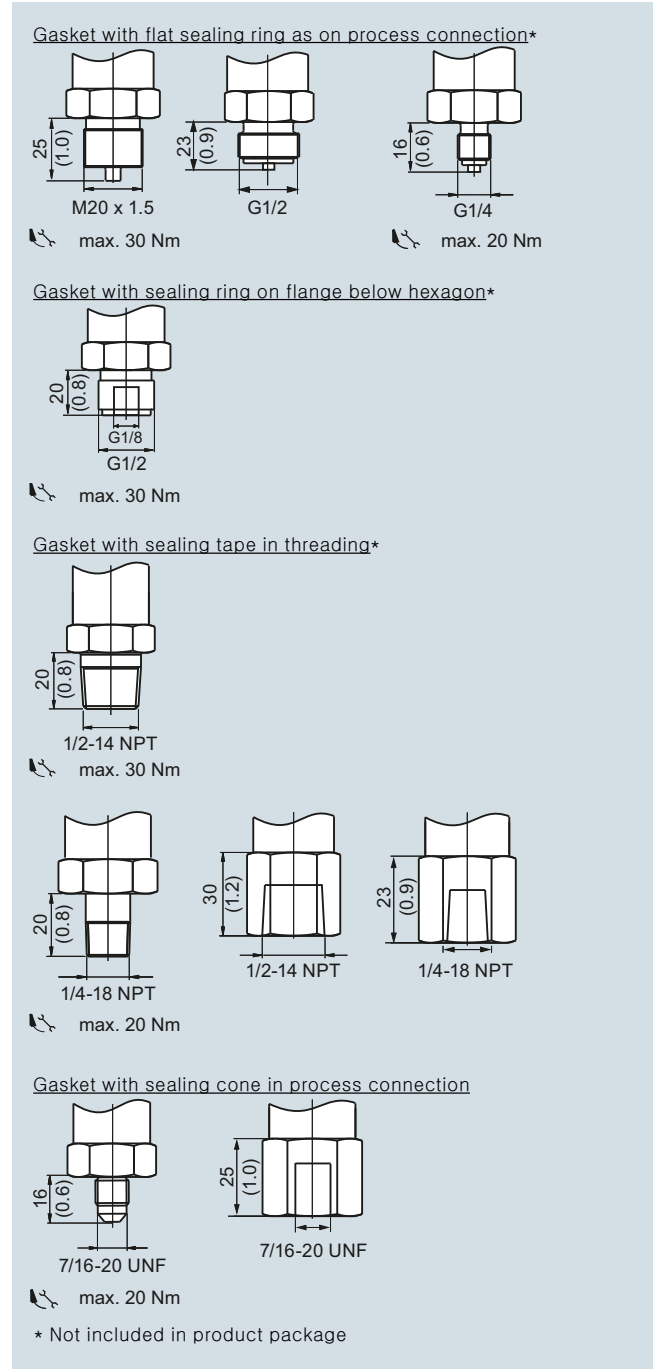

SITRANS P210, process connections, dimensions in mm (inch)

Pressure Measurement

Single-range transmitters for general applications

SITRANS P210 for gauge pressure

1

Schematics

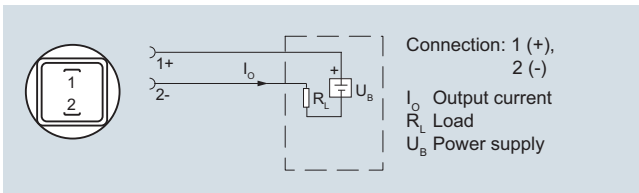

Connection with current output and connector per EN 175301

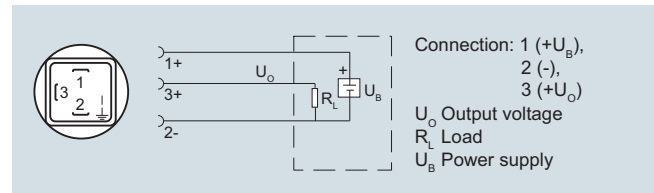

Connection with voltage output, ratiometric output and plug according to EN 175301

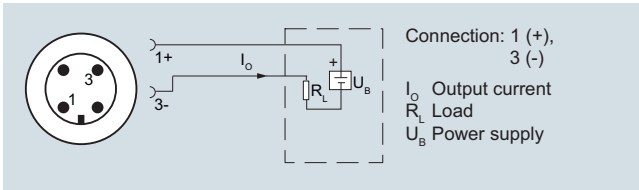

Connection with current output and connector M12x1

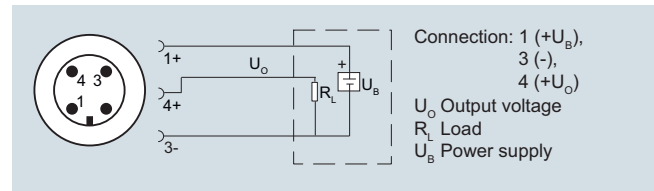

Connection with voltage output, ratiometric output and M12x1 plug

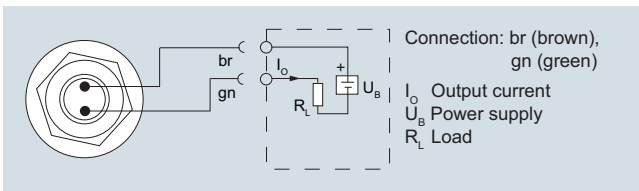

Connection with current output and cable

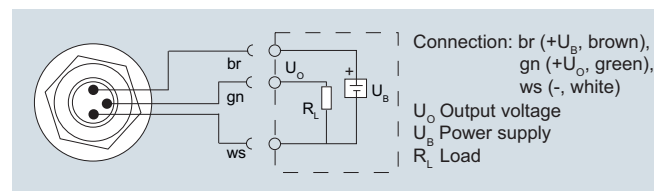

Connection with voltage output, ratiometric output and cable

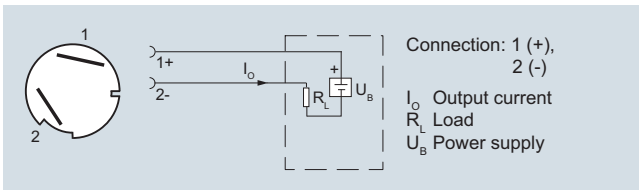

Connection with current output and Quickon cable quick screw connection

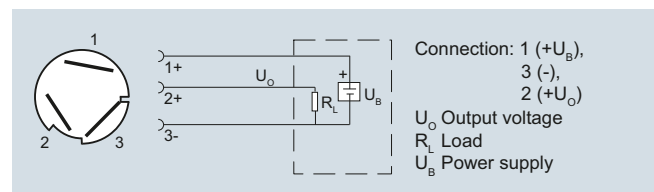

Connection with voltage output, ratiometric output and Quickon fast cable termination

Version with explosion protection: 4 ... 20 mA

The grounding connection is conductively bonded to the transmitter enclosure

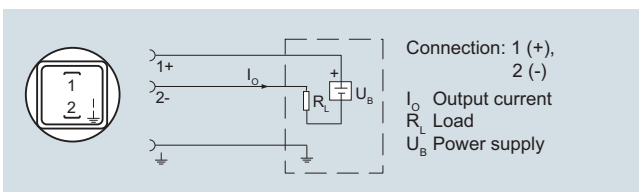

Connection with current output and connector per EN 175301 (Ex)

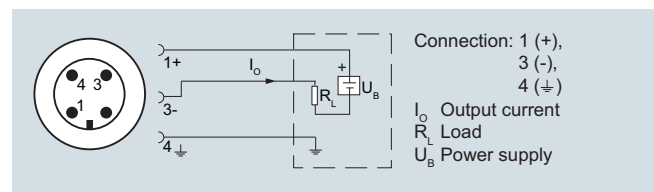

Connection with current output and connector M12x1 (Ex)

Pressure Measurement

Single-range transmitters for general applications

SITRANS P220 for gauge pressure

Overview



The pressure transmitter SITRANS P220 measures the gauge pressure of liquids, gases and vapors.

- Stainless steel measuring cell, fully welded
- Measuring ranges 2.5 to 1000 bar (36.3 to 14500 psi) relative
- For high-pressure applications and refrigeration technology division

Benefits

- High measuring accuracy
- Rugged stainless steel enclosure
- High overload withstand capability
- For aggressive and non-aggressive media
- For measuring the pressure of liquids, gases and vapors
- Compact design
- Gasket-less

Application

The pressure transmitter SITRANS P220 for gauge pressure is used in the following industrial areas:

- Mechanical engineering
- Shipbuilding
- Power engineering
- Chemical industry
- Water supply

Design

Device structure without explosion protection

The pressure transmitter consists of a piezoresistive measuring cell with a diaphragm installed in a stainless steel enclosure. It can be used with a connector per EN 175301-803-A (IP65), a round plug M12 (IP67), a cable (IP67) or a Quickon cable quick screw connection (IP67) connected electrically. The output signal is between 4 and 20 mA or 0 and 10 V.

Device structure with explosion protection

The pressure transmitter consists of a piezoresistive measuring cell with a diaphragm installed in a stainless steel enclosure. It can be used with a connector per EN 175301-803-A (IP65) or a round plug M12 (IP67) connected electrically. The output signal is between 4 and 20 mA.

Function

The pressure transmitter measures the gauge pressure of liquids and gases as well as the level of liquids.

Mode of operation

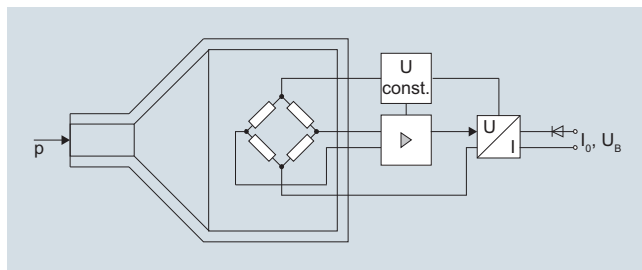

SITRANS P220 pressure transmitters (7MF1567-...), functional diagram

The stainless steel measuring cell has a thick-film resistance bridge to which the operating pressure p is transmitted through a stainless steel diaphragm.

The voltage output from the measuring cell is converted by an amplifier into an output current of 4 to 20 mA or an output voltage of 0 to 10 V DC.

The output current and voltage are linearly proportional to the input pressure.

Pressure Measurement

Single-range transmitters for general applications

SITRANS P220 for gauge pressure

1

Technical specifications

Application	Gauge pressure measurement	Liquids, gases and vapors
Mode of operation	Measuring principle	Piezoresistive measuring cell (stainless steel diaphragm)
Measured variable		Gauge pressure
Inputs	Measuring range	
• Gauge pressure		
- Metric		2.5 ... 1000 bar (36 ... 14500 psi)
- US measuring range		30... 14500 psi
Output	Current signal	4 ... 20 mA
• Load		($U_B - 10 \text{ V}$)/0.02 A
• Auxiliary power U_B		DC 7 ... 33 V (10 ... 30 V for Ex)
Voltage signal		0 ... 10 V DC
• Load		$\geq 10 \text{ k}\Omega$
• Auxiliary power U_B		12 ... 33 V DC
• Power consumption		$< 7 \text{ mA}$ at 10 k Ω
Ratiometric output		0 ... 90 %
• Load		$\geq 10 \text{ k}\Omega$
• Auxiliary power U_B		5 V DC $\pm 10 \%$
• Power consumption		$< 7 \text{ mA}$ at 10 k Ω
Characteristic curve		Linear rising
Measuring accuracy	Error in measurement at limit setting incl. hysteresis and reproducibility	<ul style="list-style-type: none"> • Typical: 0.25 % of full-scale value • Maximum: 0.5 % of full-scale value
Step response time T_{99}		$< 5 \text{ ms}$
Long-term stability		
• Lower range value and measuring span		0.25 % of full-scale value/year
Influence of ambient temperature		
• Lower range value and measuring span		0.25 %/10 K of full-scale value
• Influence of power supply		0.005 %/V
Conditions of use	• Process temperature	-40 ... +120 °C (-40 ... +248 °F)
• Ambient temperature		-25 ... +85 °C (-13 ... +185 °F)
• Storage temperature		-50 ... +100 °C (-58 ... +212 °F)
• Degree of protection (to EN 60529)		<ul style="list-style-type: none"> • IP 65 with connector per EN 175301-803-A • IP 67 with M12 connector • IP 67 with cable • IP 67 with cable quick screw connection
Electromagnetic compatibility		<ul style="list-style-type: none"> • acc. IEC 61326-1/-2/-3 • acc. NAMUR NE21, only for ATEX versions and with a max. measuring deviation $\leq 1 \%$

Design

Weight	Approx. 0.090 kg (0.198 lb)
Process connections	See dimension drawings
Electrical connections	<ul style="list-style-type: none"> • Connector per EN 175301-803-A Form A with cable inlet M16x1.5 or 1/2-14 NPT or Pg 11 • M12 connector • 2 or 3-wire (0.5 mm²) cable ($\varnothing \pm 5.4 \text{ mm}$) • Quickon cable quick screw connection
Wetted parts materials	
• Measuring cell	Stainless steel, mat.-No. 1.4016
• Process connection	Stainless steel, mat. No. 1.4404 (SST 316 L)
Non-wetted parts materials	
• Enclosure	Stainless steel, mat. No. 1.4404 (SST 316 L)
• Rack	Plastic
• cables	PVC
Certificates and approvals	
Classification according to pressure equipment directive (PED 2014/68/EU)	For gases of fluid group 1 and liquids of fluid group 1; complies with requirements of article 4, paragraph 3 (sound engineering practice)
Lloyd's Register of Shipping (LR) ¹⁾	12/20010
Germanischer Lloyd (GL) ¹⁾	GL19740 11 HH00
American Bureau of Shipping (ABS) ¹⁾	ABS_11_HG 789392_PDA
Bureau Veritas (BV) ¹⁾	BV 271007A0 BV
Det Norske Veritas (DNV) ¹⁾	A 12553
Drinking water approval (ACS) ¹⁾	ACS 15 ACC NY 360
EAC ¹⁾	№ TC RU C-DE.ГБ05.В.00732 OC НАННО «ЦСВЭ»
CRN ²⁾	0F18659.5C
Underwriters Laboratories (UL) ¹⁾	
• for USA and Canada	UL 20110217 - E34453
• worldwide	IEC UL DK 21845
Explosion protection	
Intrinsic safety "i" (only with current output)	Ex II 1/2 G Ex ia IIC T4 Ga/Gb Ex II 1/2 D Ex ia IIIC T125 °C Da/Db
EC type-examination certificate	SEV 10 ATEX 0146
Connection to certified intrinsically-safe resistive circuits with maximum values:	$U_i \leq 30 \text{ V DC}$; $I_i \leq 100 \text{ mA}$; $P_i \leq 0.75 \text{ W}$
Effective internal inductance and capacity for versions with plugs per EN 175301-803-A and M12	$L_i = 0 \text{ nH}$; $C_i = 0 \text{ nF}$
CSA ²⁾	70006348 Class I, Division 1, Groups A, B, C and D; Class II, Division 1, Groups E, F and G, Class III Class I, Division 2, Groups A, B, C and D; Class II, Division 2, Groups F and G, Class III A/Ex ia IIC T4 Ga/Gb A/Ex ia IIIC T125°C Da/Db

¹⁾ For variants with output signal 0 ... 5 V and ratiometric output available soon.

²⁾ See ordering data for available versions.

Pressure Measurement

Single-range transmitters for general applications

SITRANS P220 for gauge pressure

1

Selection and ordering data

SITRANS P 220 pressure transmitters for gauge pressure, high-pressure and refrigeration applications, fully-welded version

Accuracy typ. 0.25 %

Wetted parts materials: stainless steel

Non-wetted parts materials: stainless steel

Click on the Article No. for the online configuration in the PIA Life Cycle Portal.

Article No.

Order code

7MF1567 - - A

Measuring range

Overload limit

Mini-
mum

Max.

Burst pressure

For gauge pressure

0 ... 2.5 bar	(0 ... 36.3 psi)	-1 bar (-14.5 psi)	6.25 bar (90.7 psi)	25 bar (363 psi)	▶◆	3BD
0 ... 4 bar	(0 ... 58 psi)	-1 bar (-14.5 psi)	10 bar (145 psi)	40 bar (870 psi)	▶◆	3BE
0 ... 6 bar	(0 ... 87 psi)	-1 bar (-14.5 psi)	15 bar (217 psi)	60 bar (522 psi)	▶◆	3BG
0 ... 10 bar	(0 ... 145 psi)	-1 bar (-14.5 psi)	25 bar (362 psi)	60 bar (870 psi)	▶◆	3CA
0 ... 16 bar	(0 ... 232 psi)	-1 bar (-14.5 psi)	40 bar (580 psi)	96 bar (1392 psi)	▶◆	3CB
0 ... 25 bar	(0 ... 363 psi)	-1 bar (-14.5 psi)	62.5 bar (906 psi)	150 bar (2176 psi)	▶◆	3CD
0 ... 40 bar	(0 ... 580 psi)	-1 bar (-14.5 psi)	100 bar (1450 psi)	240 bar (3481 psi)	▶◆	3CE
0 ... 60 bar	(0 ... 870 psi)	-1 bar (-14.5 psi)	150 bar (2175 psi)	360 bar (5221 psi)	▶◆	3CG
0 ... 100 bar	(0 ... 1450 psi)	-1 bar (-14.5 psi)	250 bar (3625 psi)	600 bar (8702 psi)	▶◆	3DA
0 ... 160 bar	(0 ... 2320 psi)	-1 bar (-14.5 psi)	400 bar (5801 psi)	960 bar (13924 psi)	▶◆	3DB
0 ... 250 bar	(0 ... 3625 psi)	-1 bar (-14.5 psi)	625 bar (9064 psi)	1500 bar (21756 psi)	▶◆	3DD
0 ... 400 bar	(0 ... 5801 psi)	-1 bar (-14.5 psi)	1000 bar (14503 psi)	2400 bar (34809 psi)	▶◆	3DE
0 ... 600 bar	(0 ... 8702 psi)	-1 bar (-14.5 psi)	1500 bar (21755 psi)	3600 bar (52200 psi)	▶◆	3DG
0 ... 1000 bar	(0 ... 14500 psi)	-1 bar (-14.5 psi)	1500 bar (21755 psi)	5000 bar (72520 psi)	▶◆	3EA

Other version, add Order code and plain text:

Measuring range: ... up to... bar (psi)

Measuring ranges for gauge pressure

0 ... 30 psi	-14.5 psi	75 psi	360 psi	*	4BE
0 ... 60 psi	-14.5 psi	150 psi	580 psi	*	4BF
0 ... 100 psi	-14.5 psi	250 psi	580 psi	*	4BG
0 ... 150 psi	-14.5 psi	375 psi	870 psi	*	4CA
0 ... 200 psi	-14.5 psi	500 psi	1390 psi	*	4CB
0 ... 300 psi	-14.5 psi	750 psi	2170 psi	*	4CD
0 ... 500 psi	-14.5 psi	1250 psi	3480 psi	*	4CE
0 ... 750 psi	-14.5 psi	1875 psi	5220 psi	*	4CF
0 ... 1000 psi	-14.5 psi	2500 psi	5220 psi	*	4CG
0 ... 1500 psi	-14.5 psi	3750 psi	8700 psi	*	4DA
0 ... 2000 psi	-14.5 psi	5000 psi	13920 psi	*	4DB
0 ... 3000 psi	-14.5 psi	7500 psi	21750 psi	*	4DD
0 ... 5000 psi	-14.5 psi	12500 psi	34800 psi	*	4DE
0 ... 6000 psi	-14.5 psi	15000 psi	34800 psi	*	4DF
0 ... 8700 psi	-14.5 psi	21755 psi	52200 psi	*	4DG
0 ... 14500 psi	-14.5 psi	21755 psi	72520 psi	*	4EA

Other version, add Order code and plain text: Measuring range: ... up to ... psi

Output signal

4 ... 20 mA; two-wire system; power supply 7 ... 33 V DC (10 ... 30 V DC for ATEX versions)	▶◆	0
0 ... 10 V; three-wire system; power supply 12 ... 33 V DC		10
0 ... 5 V; 3-wire system; auxiliary power 7 ... 33 V DC		20
Ratiometric 10 ... 90 %; 3-wire system; auxiliary power 5 V DC ± 10 %		30

Explosion protection (only 4 ... 20 mA)

None	▶◆	0
With explosion protection Ex ia IIC T4	▶◆	1

Electrical connection

Connector per DIN EN 175301-803-A, stuffing box thread M16 (with coupling)	▶◆	1
Round connector M12 per IEC 61076-2-101	*	2
Connection via fixed mounted cable, 2 m (not for type of protection "Intrinsic safety i")		03
Quickon cable quick screw connection PG9 (not for type of protection "Intrinsic safety i")		04
Connector per DIN EN 175301-803-A, stuffing box thread 1/2"-14 NPT (with coupling)	*	5
Connector per DIN EN 175301-803-A, stuffing box thread PG11 (with coupling)	*	6
Fixed mounted cable, length 5 m		07
Special version		9

▶ Available ex stock

◆ We can offer shorter delivery times for configurations designated with the Quick Ship Symbol ◆. For details see page 10/11 in the appendix.

* Order code E21 required for complete configuration with CRN and cCSAusEx approval.

Pressure Measurement

Single-range transmitters for general applications

SITRANS P220 for gauge pressure

1

Selection and ordering data	Article No.	Order code
SITRANS P 220 pressure transmitters for gauge pressure, high-pressure and refrigeration applications, fully-welded version Accuracy typ. 0.25 % Wetted parts materials: stainless steel Non-wetted parts materials: stainless steel	7MF1567 - - - - -	A
Process connection G½" male per EN 837-1 (½" BSP male) (standard for metric pressure ranges mbar, bar) ▶◆ G½" male thread and G1/8" female thread G¼" male per EN 837-1 (¼" BSP male) 7/16"-20 UNF male ¼"-18 NPT male (standard for pressure ranges inH ₂ O and psi) ★ ¼"-18 NPT female (Only for measuring ranges ≤ 60 bar (870 psi)) ½"-14 NPT male ½"-14 NPT female (Only for measuring ranges ≤ 60 bar (870 psi)) 7/16"-20 UNF female M20x1.5 male G1/4" to DIN 3852 Form E G1/2" to DIN 3852 Form E Special version		A B C D E F G H J P Q R Z P1Y
Version Standard version ▶◆★		1
Further designs Supplement the Article No. with "-Z" and add Order code. Quality Inspection Certificate (5-point characteristic curve test) according to IEC 60770-2 Oxygen version, free of oil and degreased (not in conjunction with explosion protection version) With CRN and cCSAusEx approval ▶ Available ex stock ◆ We can offer shorter delivery times for configurations designated with the Quick Ship Symbol ◆. For details see page 10/11 in the appendix. ★ Order code E21 required for complete configuration with CRN and cCSAusEx approval..		C11 E10 E21

Pressure Measurement

Single-range transmitters for general applications

SITRANS P220 for gauge pressure

1

Dimensional drawings

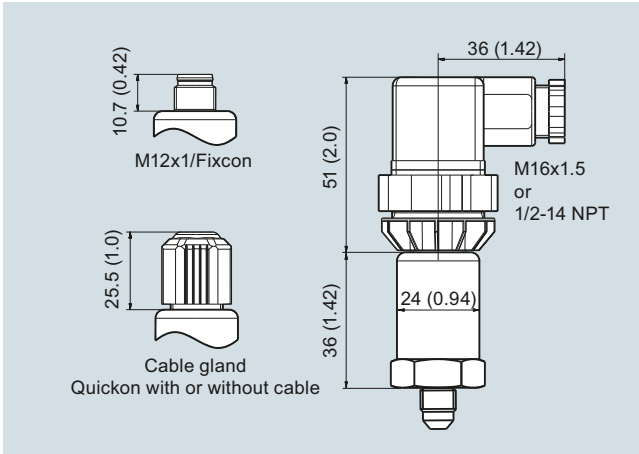

SITRANS P220, electrical connections, dimensions in mm (inch)

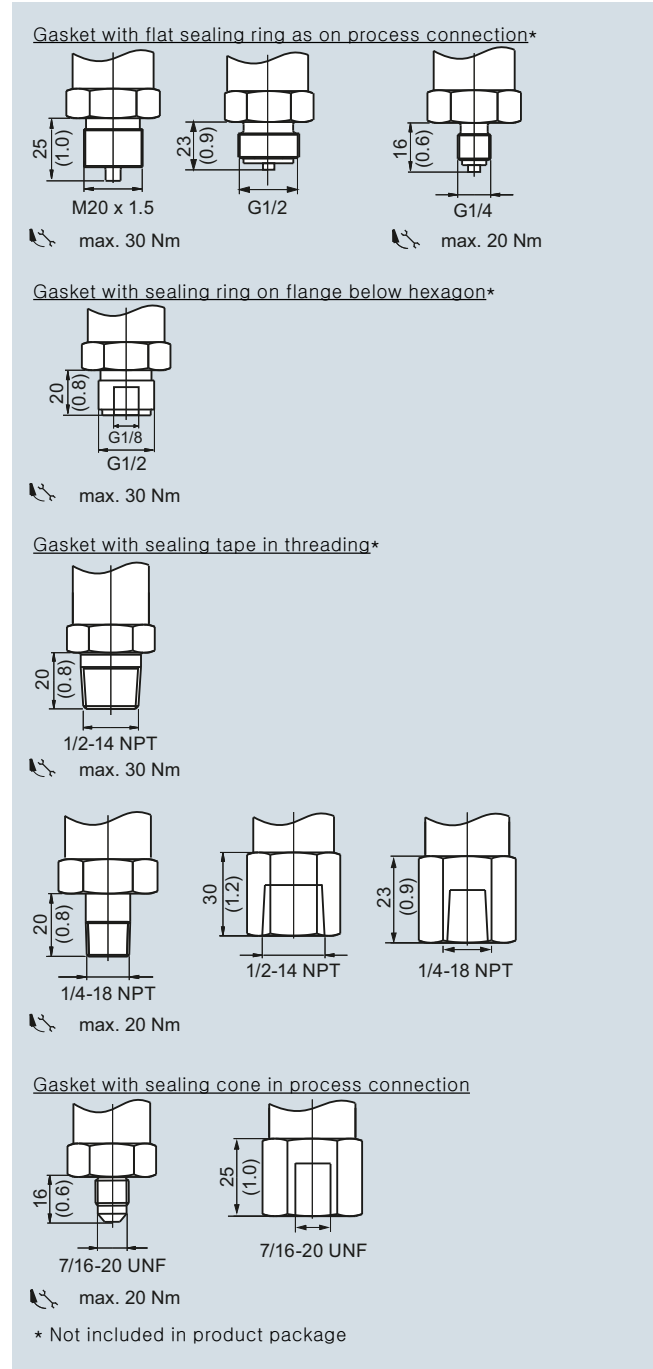

SITRANS P220, process connections, dimensions in mm (inch)

Pressure Measurement

Single-range transmitters for general applications

SITRANS P220 for gauge pressure

1

Schematics

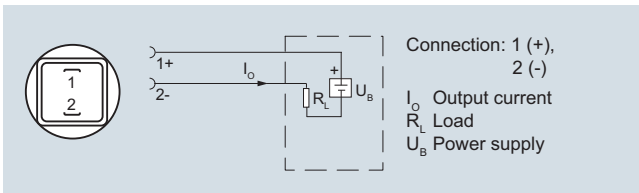

Connection with current output and connector per EN 175301

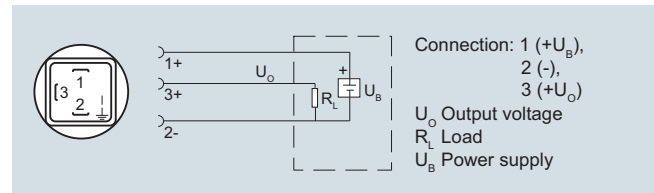

Connection with voltage output, ratiometric output and plug according to EN 175301

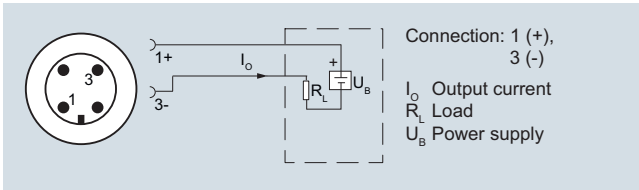

Connection with current output and connector M12x1

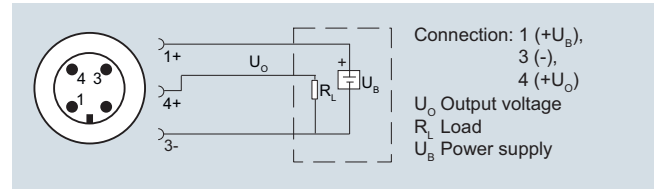

Connection with voltage output, ratiometric output and M12x1 plug

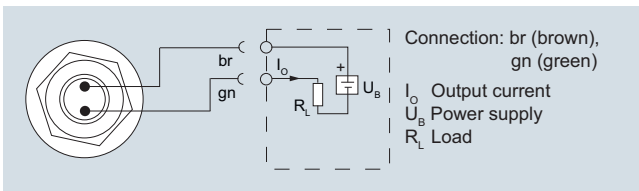

Connection with current output and cable

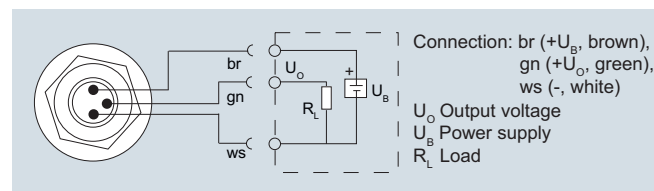

Connection with voltage output, ratiometric output and cable

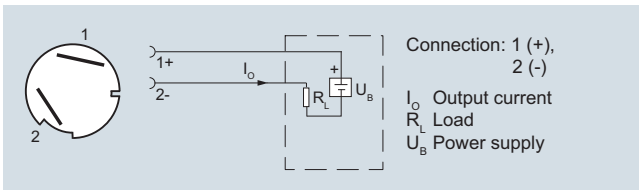

Connection with current output and cable quick screw connection Quickon

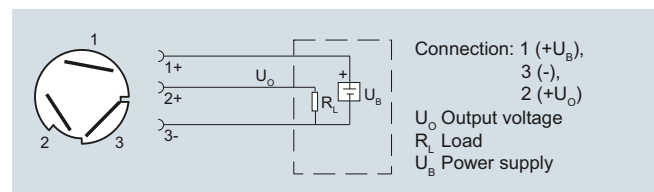

Connection with voltage output, ratiometric output and Quickon fast cable termination

Version with explosion protection: 4 ... 20 mA

The grounding connection is conductively bonded to the transmitter enclosure

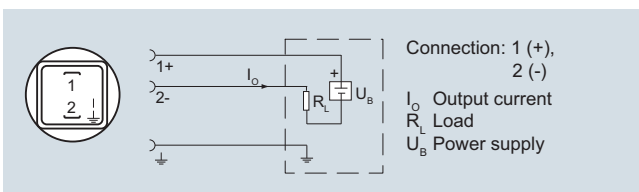

Connection with current output and connector per EN 175301 (Ex)

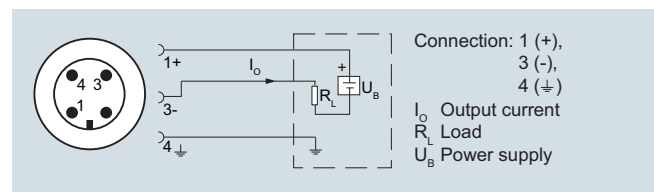

Connection with current output and connector M12x1 (Ex)