

Small Valves

DIN-range with a higher k_v -value

VD1...CLC

- Valve body made of brass, mat nickel-plated
- DN 15, DN 20 and DN 25
- Internally and externally threaded (Rp / R) conforming to ISO 7-1
- Manual knob / protective cover included in the delivery
- Can be combined with motoric SSA...-, thermal STA...- and STS61...- actuators

Use

- For use in ventilation and air conditioning systems for water-side control of chilled ceilings and terminal units in closed circuits, e.g. for induction units, fan coil units, small re-heaters and small re-coolers.
 - 2-pipe systems with 1 heat exchanger for heating and cooling
 - 4-pipe systems with 2 separate heat exchangers for heating and cooling
- In closed-circuit zone heating systems, e.g. for:
 - Separate floors in a building
 - Apartments
 - Individual rooms

Type summary

Type reference	DN	k_v -value setting range [m ³ /h)
VD115CLC	15	0.25...1.9
VD120 CLC	20	0.25...2.6
VD125 CLC	25	0.25...2.6

Order

When ordering, please give quantity, product name and type reference.

Example: 2 small valves VD120CLC

Delivery

Valves, actuators and accessories are packed separately.

Equipment combinations

Product	Types	Data sheet
Electromotoric actuators	SSA31... / SSA61... ¹⁾ / SSA81...	N4893
	SSA955 ²⁾	N2700
Thermal actuators 2-position	STA21 / STA71	N4877
Thermal actuators DC 0...10 V	STS61...	N4880

¹⁾ Preadjustment of flow rate: > 1.5 mm valve stroke.

If the valve travel is less than 1.5 mm, self-calibration is not possible and the valve with the actuator remains blocked.

²⁾ Preadjustment of flow rate: > 0.5 mm valve stroke.

If the valve travel is less than 0.5 mm, self-calibration is not possible and the actuator generates an error message.

Mechanical and technical design

The valves make possible flow rate preadjustments by limiting the stroke. A preadjusting screw with reference numbers from 0 to 7 is located under the protective cover right by the valve stem.

- 1 Gland with preadjusting ring
- 2 Valve insert
- 3 Fitting with O-ring
- 4 Valve plug with soft disk
- 5 All valves are supplied with a protective cover. That cover facilitates shutoff when making the plant pressure test and manual adjustments for improvised plant operation during the construction phase.

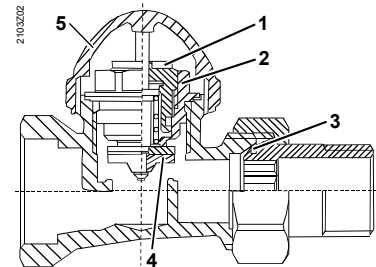

Engineering notes

The reference numbers for preadjustment are given in the table with the k_v -values (see page 3) and in the valve sizing charts (see page 4).

1. Calculate the volumetric water flow \dot{V}_{100}

$$\dot{V}_{100} = \frac{Q_{100}}{1.163 \times \Delta T \times f_1} \quad [\text{m}^3/\text{h}]$$

Q_{100} = heat/refrigeration demand [kW]
 ΔT = temperature differential [K]
 1.163 = constant of water
 f_1 = correction factor = 1 for water

2. Define the pressure drop Δp_{v100} across the fully open valve

In most types of plant, a differential pressure Δp_{v100} of 0.05 to 0.2 bar is adequate (5 to 20 kPa).

3. Calculation of the nominal flow value k_v

$$k_v = \frac{\dot{V}_{100}}{\sqrt{\Delta p_{v100}}} \quad [\text{m}^3/\text{h}]$$

Δp_{v100} = pressure drop across the valve [bar]

Example:

Heat demand	Q_{100}	= 4.7 kW
Temperature differential	ΔT	= 8 K
Volumetric water flow	$\dot{V}_{100} = \frac{4.7}{1.163 \times 8}$	= 0.51 m ³ /h (510 l/h)
Required pressure drop across the valve	Δp_{v100}	= 0.1 bar
Flow	$k_v = \frac{0.51}{\sqrt{0.1}}$	= 1.61 m ³ /h

Solution

According to the chart (refer to « Valve sizing charts») or table with k_v -values, the preadjustment required by a VD120CLC valve is 6.

Tips

- Noiseless operation is ensured by a pump that provides no more pressure than is needed to transport the required amount of water.
- To keep the valve free from dirt particles, it is recommended to install a strainer.
- If no pressure drop calculation is executed, preadjustment should be set with a differential pressure Δp_{v100} of 0.1 bar (10 kPa).

Valve data

k_v -values at the different preadjusted positions [m³/h]

Reference numbers for preadjustment	0 ¹⁾	1	2	3	4	5	6	7	0 ²⁾
Valve stroke [mm]	0	0.188	0.375	0.563	0.75	0.938	1.125	1.313	1.5
VD115CLC	0	0.25	0.65	0.88	1.12	1.30	1.46	1.57	1.90
VD120CLC	0	0.25	0.60	0.91	1.18	1.43	1.64	1.85	2.60
VD125CLC	0	0.25	0.60	0.91	1.18	1.43	1.64	1.85	2.60
Flow tolerance [± %]	0	60	30	20	10	10	10	10	10

 Preadjustments < 5 are not recommended because the stroke resolution is too small.

Note

- The k_v -values give the volumetric water flow \dot{V} in m³/h passing through the valve at a pressure drop Δp of 1 bar across the valve.
- The preadjusting ring permits 2 full revolutions. The values given in the table (reference numbers 0¹⁾... 0²⁾) define the first revolution. After another revolution (reference number 0²⁾...6), the stroke still increases to 2.5 mm (fully open), but the k_v values will not exceed 0²⁾.
- The valves are supplied with the preadjusting ring fully opened (reference number 0²⁾). To make a preadjustment, the ring must first be fully closed – only then can the required reference number be selected. The markings on the different types are not necessarily identical.

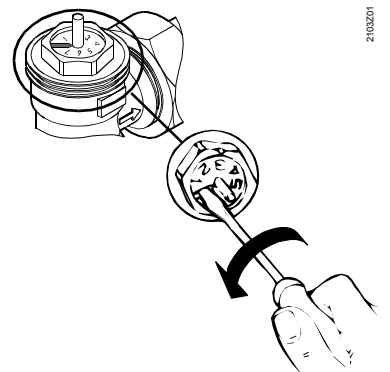

2103201

VD115CLC

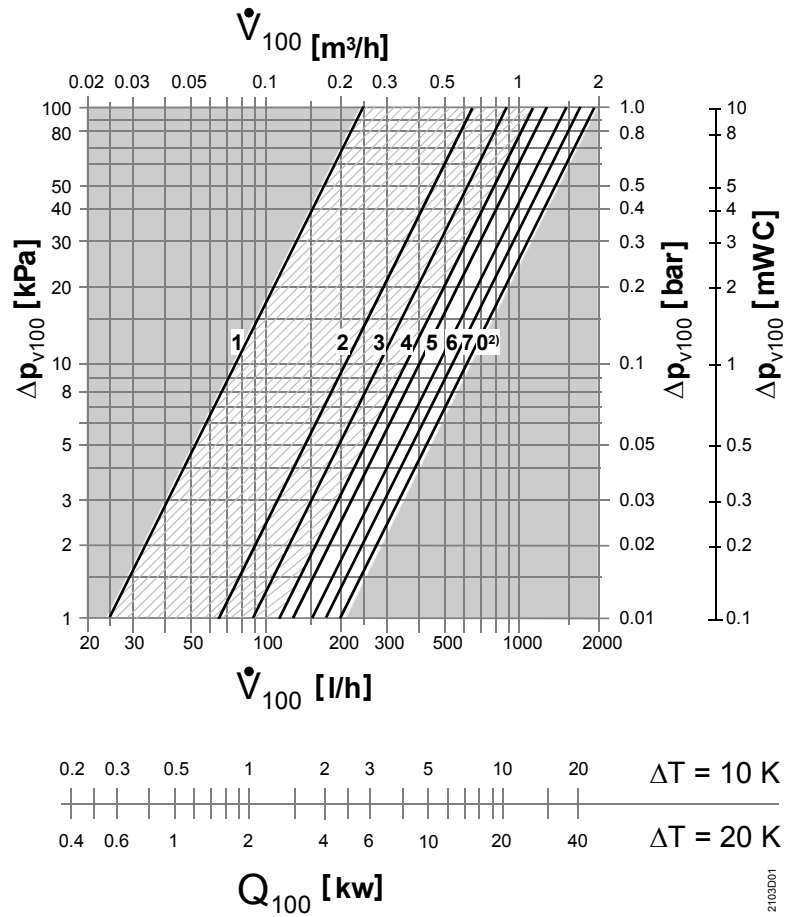

2103D01

VD120CLC
VD125CLC

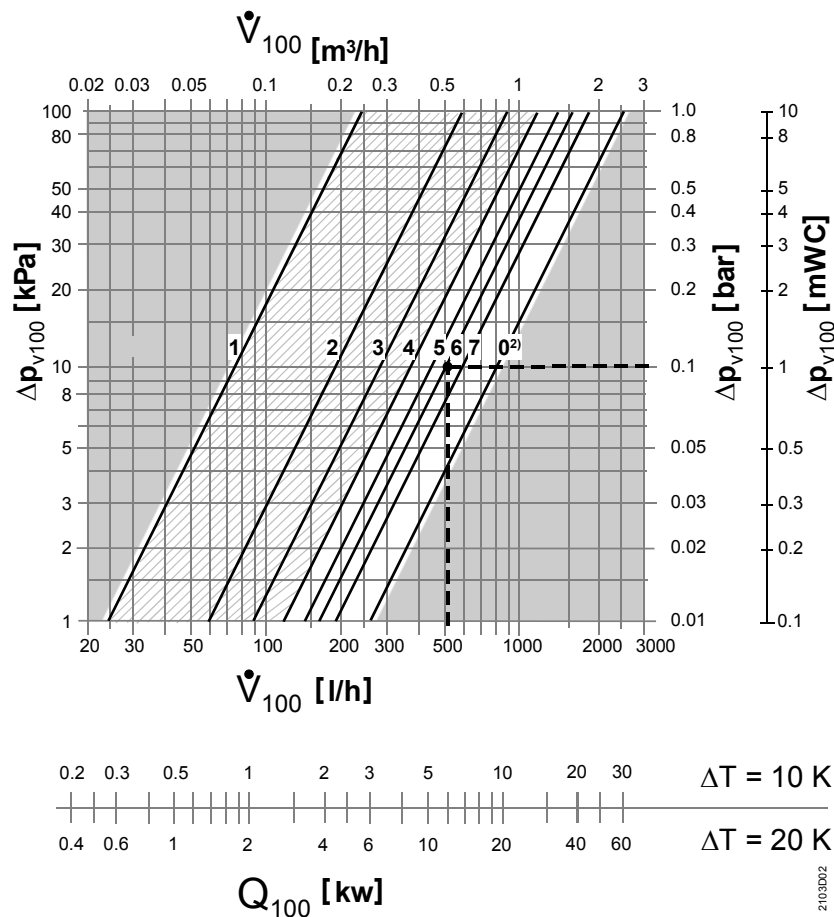

2103D02

Mounting notes

- To ensure correct functioning of the thermostatic heads and electromotoric actuators, observe the available mounting choices and mounting conditions.
- VD1...CLC remains open if no actuator is mounted.

Orientation

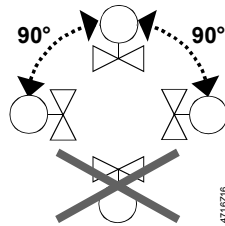

Maintenance

The small valves are maintenance-free.

Repair

The valves cannot be repaired; the complete units must be replaced.

Disposal



The valve must not be disposed of together with domestic waste.

Legislation may demand special handling of certain components, or it may be sensible from an ecological point of view.

Current local legislation must be observed.

Warranty

Application-related technical data are only warranted when used in connection with the Siemens controllers and actuators listed under «Equipment combinations».

When using the radiator valves with actuators of other manufacture, any warranty by Siemens Switzerland Ltd / HVAC Products becomes void.

Technical data

Functional data	PN class	PN 10		
	Permissible media	chilled water, low temperature hot water, water with anti-freeze; recommendation: water treatment to VDI 2035		
	Medium temperature	1...110 °C		
	Perm. operating pressure	1000 kPa (10 bar)		
	Differential pressure Δp_{\max}	max. 150 kPa (1.5 bar)		
	Differential pressure Δp_{v100}	5...20 kPa (0.05 ... 0.20 bar): recommended range		
	Nominal stroke	2.5 mm		
Industry standards	Pressure Equipment Directive	PED 97/23/EC		
	Pressure Accessories	as per article 1, section 2.1.4		
	Fluid group 2	without CE-marking as per article 3, section 3 (sound engineering practice)		
Materials	Valve body	brass CuZn40Pb2, mat nickel-plated		
	Fitting	brass CuZn40Pb2, mat nickel-plated		
	Protective cover	polypropylene		
	O-ring	EPDM		
Dimensions / weight	refer to «Dimensions»			
	Mounting length	EN215		
	Thread	Rp internally threaded	to ISO 7-1	
		R externally threaded	to ISO 7-1	
G-thread		to ISO 228-1		

Dimensions

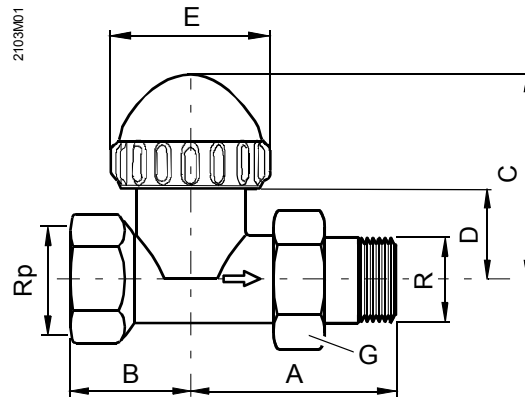

Type	DN	Dimensions [mm]					Thread [inch]			Weight [kg]
		A	B	C	D	E	Rp	R	G	
VD115CLC	15	61	33	46.5	24.5	35	1/2	1/2	3/4	0.28
VD120CLC	20	65	40				3/4	3/4	1	0.33
VD125CLC	25	68	35				1	1	1	0.42